

Videonics Video TitleMaker 2000
MODEL TM-2000

INSTRUCTION MANUAL



VIDEONICS
The Video Editing Company

Videonics Video TitleMaker 2000
MODEL TM-2000

INSTRUCTION MANUAL



TM-2000 Video TitleMaker 2000 Instruction Manual • MANL-0526-02 • © 1994 Videonics, Inc.

The Videonics logo, Thumbs Up, and Videonics Video TitleMaker are registered trademarks of Videonics, Inc. TM-2000 and MX-1 Digital Video Mixer are trademarks of Videonics.

Product and brand names may be trademarks or registered trademarks of their respective companies and are hereby acknowledged.

Television screens are simulated.

Subject to change without notice.

This device is not to be used for the unauthorized copying of copyrighted material.

CONTROLS

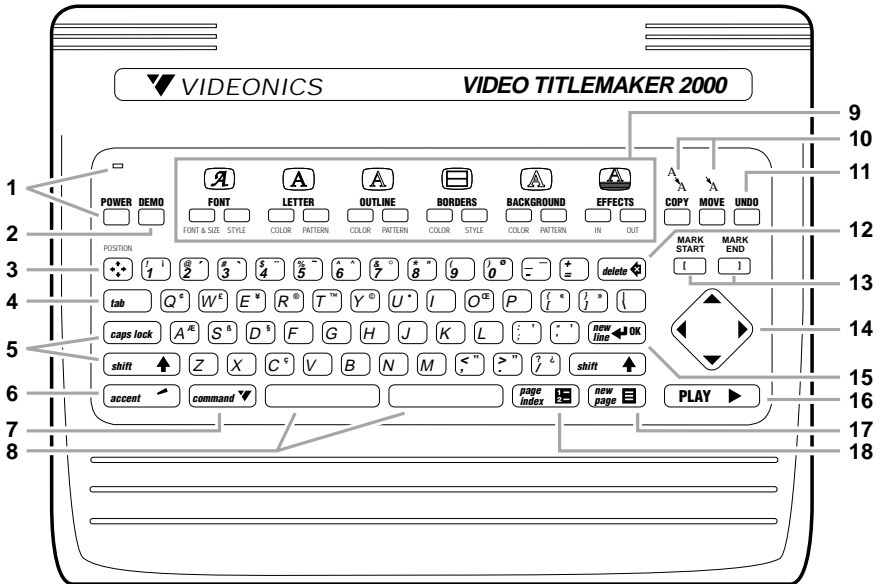

1. **POWER** key turns unit on. **POWER** light illuminates when power is on. When unit is off, video is passed from **VIDEO IN** to **VIDEO OUT** as long as power supply is plugged into live outlet. All titles and settings are saved when unit is off. *Note: To guard against loss of titles, never unplug unit until power light goes out.* (Chapter 3)
2. **DEMO**. Demonstrates features. You can also copy the demo into the editing area, to modify it or study how its effects were accomplished. (Chapter 5)
3. **POSITION**. Press and release this, followed by up or down arrow, to position text at the top, bottom, or center of the page. Press and release this, then left or right arrow, to position lines at right, left, or center page. (Chapter 10)
4. **TAB**. "Smart tab" positions cursor to match spaces in previous line of text. (Chapter 6)
5. **SHIFT** and **CAPS LOCK**. Hold **SHIFT** to type capital letters. **CAPS LOCK** capitalizes all typing until pressed again. Note that some fonts have only capital letters. **SHIFT** is also used to modify the function of other keys. (Chapters 6, Appendix A)
6. **ACCENT**. Hold **ACCENT** while typing a letter key to type the special symbols (•, ©, ¢, etc.) printed in gold. Use with arrow keys to type arrow characters. Use with accent marks followed by a letter to type accented international characters such as é, ü, ã, etc. (Chapter 6)
7. **COMMAND**. Modifies function of other keys. (Appendix A)
8. **SPACE BARS**. Adds space to text. Both halves behave identically.
9. **MENU KEYS**. Menus change color, font, style, etc. of lines or pages that contain marked text or cursor. Use **MARK START** to change sub-menus, arrow keys to highlight the desired choice, **NEW LINE/OK** or **PLAY** to implement changes. Press **UNDO** to cancel the menu and leave titles unchanged. (Chapters 11-17)
10. **COPY** and **MOVE**. To copy or move text, mark the text using **MARK START** and **MARK END**, move cursor to desired location, then press **COPY** or **MOVE**. (Chapters 7-9)
11. **UNDO**. If you accidentally delete something, press **UNDO** immediately.

12. DELETE. Erases marked text, if any. Otherwise, erases character before the cursor.
13. MARK START and MARK END. Mark text to modify, delete, copy, or move it. Position cursor before first character and press MARK START. Position after last character and press MARK END. Notice cursor becomes wider to remind you something is marked. Use UNDO to remove marks. SHIFT, used with a mark key, marks start or end of the page; COMMAND plus a mark key marks start or end of all text. (Chapters 7-9)
14. ARROW KEYS. Use arrow keys to move cursor on screen; to change highlights in a menu; and, when playing text, to go forward and backward. SHIFT makes arrow act on a page at a time; COMMAND with UP or DOWN goes to top or bottom of all text. With ACCENT, arrows type arrow characters. COMMAND + SHIFT + UP or DOWN moves you between projects. (Chapter 6, 11, 19)
15. NEW LINE/OK ends a line of text and starts a new one. Also accepts settings of menus, returns to Editing Screen from Page Index and Play Screens. (Chapter 6)
16. PLAY. After you create titles using the Editing Screen, press PLAY to display the titles for display or recording. COMMAND + PLAY always plays from first page in project; PLAY alone plays marked pages or, if none are marked, starts playing from cursor. Once playing begins: Press PLAY again to go to next page; use SHIFT to play backwards; press arrow keys to manually step forward or backwards. NEW LINE/OK ends play and returns to Editing Screen. (Chapter 19)
17. NEW PAGE starts a new page of text. COMMAND + NEW PAGE starts a new project when Page Index is on screen. (Chapters 7-8)
18. PAGE INDEX. Displays an index in which each page occupies one line, making it easy to look through all pages and projects. Projects are created and named using PAGE INDEX. (Chapter 8)

REAR PANEL

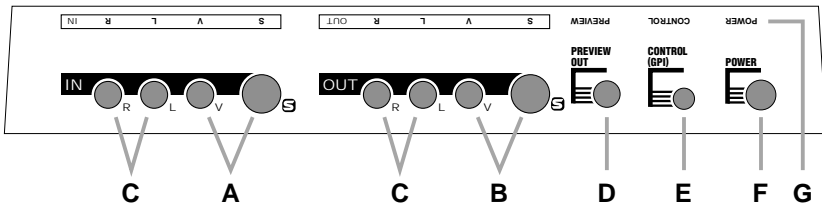

NOTE: S-video (Y/C) and composite (RCA-style) video jacks are provided. Use same type for input and output — for instance, if your video source only has RCA jacks, use RCA for both even if the recorder has S-video.

- A. VIDEO IN. Optional. Connect either S-video or RCA type cable from video source.
- B. VIDEO OUT. Connect either S-video or RCA type cable (same as used for input) to recorder or monitor.
- C. AUDIO IN and OUT. Audio connections are provided for convenience; the audio signals pass straight through without modification.
- D. PREVIEW OUT. Optional. When used in live title setup, permits you to modify titles and typing is not seen on main output. *Important: Leave unconnected when not in use.* (Chapter 21)
- E. CONTROL (GPI). Allows remote trigger of titles using switch or controller with GPI (“General Purpose Interface”) output. *Warning: Always turn power off before connecting or disconnecting GPI jack.* (Chapter 20)
- F. POWER. Connect TitleMaker 2000 power supply. *Important: Do not use power supplies designed for any other equipment.*
- G. Upside-down legends make it easier to make connections without turning unit around.

Contents

Chapter 1 • Introduction	1	Chapter 7 • Pages	30
In a Hurry?	1	About Pages	30
Helpful Hints	1	Long Pages	30
What is a Video Titler?	1	Creating a Page	30
What is the TitleMaker 2000?	1	Page Symbols	31
Basic Applications	2	Navigating Pages and Projects with the Page Index	31
Equipment	3	Deleting a Page	32
Chapter 2 • QuickStart	4	Inserting a Page	32
Chapter 3 • Connections	11	Moving and Copying Pages	33
Connections: Overall Concept	11	Chapter 8 • Projects	34
What You'll Need	11	About Projects	34
Types of Input and Output Jacks	12	Examples of How Projects are Used	34
Types of Cables Used with the TitleMaker 2000.	12	Viewing Projects	35
IN and OUT Markings	13	Creating a Project	35
Connection Diagram	14	Naming a Project	35
Connecting Power	14	Removing a Project or Erasing its Contents	35
Turning Power On and Off: Video Pass-Through and Data Protection	14	Moving Between Projects	36
Connecting Outputs and Monitors	15	Copying or Moving Text Between Projects	36
Connecting a Video Source	17	Chapter 9 • Changing Titles	37
Troubleshooting Hints	18	Undo	37
Chapter 4 • Connecting Editing Equipment	19	Simple Changes	37
Concept	19	Marking Text for Major Changes	37
Videonics Equipment Arrangements	19	Marking Whole Lines and Pages	38
Single-Source Editing Setup	20	Deleting Marked Text	38
Use with Video Processors	21	Replacing Marked Text	38
Multiple Source Editing with a Video Mixer	21	Moving and Copying Text	39
GPI Control	21	Chapter 10 • Positioning Text	41
Chapter 5 • Using the Demo	23	Positioning Horizontally: Left, Right, Center	41
Using the Demo	23	Positioning Vertically: Up, Down, Center	41
International Demo	23	Additional Positioning Hints	42
Locked Demo	23	Chapter 11 • How to Use Menus	43
Using the Demo as a Guided Tour	23	Concept	43
Using the Demo to Create Titles	24	Sub-menus	43
Chapter 6 • Typing Titles	25	Highlights and Choices	43
The Editing Screen and Cursor	25	Using the Menu	44
Moving Around the Screen	25	Chapter 12 • How Characteristics Affect Text	45
Shortcuts for Moving the Cursor	25	Concept	45
Typing Titles	26	How Characteristics Affect Lines and Pages	45
Columns (Tabs)	26		
Typing Special and Accented Characters	27		

Contents

Changes	46	Making Titles Come and Go	65
Copying Characteristics	47	Chapter 19 • Playing Titles	66
Chapter 13 •		Projects	66
Fonts, Sizes, and Styles	48	Important Concepts	66
Font and Size	48	Playing All Pages	66
Upper-Case-Only and		Playing Some Pages	67
Fonts and Mixed Fonts	49	Playing Backwards	67
Hints on Using Fonts and Sizes	49	Pause	67
Title Style	49	Search (Cue and Review)	67
Hints on Using Styles	50	Manual Play (Slide Projector Mode)	67
Chapter 14 • Colors	52	Continuous Play (Video Billboard)	69
Color Menus	52	Leaving Play to Edit Again	69
Using the User Colors	53	Chapter 20 • Editing, Presentations,	
Hints on Using Colors	54	and Other Applications	70
Chapter 15 • Patterns	55	Applications	70
Pattern Menus	55	Video Editing	70
Selecting Different Rainbow		Presentations	73
and Pixel Patterns	56	Live Titles	74
Mixing Video into a Background Pattern	56	Chapter 21 • Preview	75
Hints on Using Patterns	56	About Preview	75
Chapter 16 • Borders	58	Using a PREVIEW Monitor	75
Border Style Menu	58	Forcing Preview Mode	75
Complex Borders	59	Appendix A •	
Removing borders	59	Advanced Techniques, Shortcuts, and	
Chapter 17 •		Command Keys	76
Effects, Scrolls, and Crawls	60	Capacity	76
Page Symbols	60	Erasing Memory and Resetting Unit	77
Effects Menus	60	Moving the Cursor	77
Transition Effects: Cuts, Fades, Slides,		Projects	77
and Wipes	60	Moving In the Color Menu	78
Slide Notes	61	Using the Demo	78
Choosing a Transition Effect	61	Play Modes	78
Setting the Transition Speed	61	Miscellaneous Hints	79
Displaying the Page	62	Appendix B • Font Listing	80
Setting Duration	62	Character Set	80
Infinite Duration	62	Font Sample	81
Scroll and Crawl	62	SPECIAL CHARACTERS	82
Scroll and Crawl Notes	63	ACCENTED CHARACTERS	82
Hints on Using Effects	63	Appendix C • Glossary	83
Chapter 18 •		Index	87
Superimposing Titles	64		
Superimposing Titles on Video	64		
Superimposing Titles on Video			
with a Transparent Pattern	64		

Chapter 1 • Introduction

Congratulations on your purchase of the Videonics Video TitleMaker® 2000. With the TitleMaker 2000, you can add brilliant, full color titles to all your videos. Its wide choice of fonts, sizes, styles, colors, borders, backgrounds, fades, wipes, scroll, crawl, and more make the TitleMaker 2000 a creative tool for anyone who uses video.

In a Hurry?

If you want to get started quickly, see the QuickStart section, Chapter 2.

Helpful Hints

The TitleMaker 2000 is a sophisticated video production tool. Some of the words and concepts used in this manual may be new to you. Specialized terms indicated by italics are defined in the Glossary section of this manual.

You can find complete descriptions of titling concepts and techniques as they apply to the TitleMaker 2000 by referring to the Table of Contents and Index.

For More Information...

...send in your registration card so we can keep you informed of new developments and send you our newsletter*. Note that Videonics does not sell its mailing list. Your name and address will remain confidential.

What is a Video Titler?

A *titler* (also called a *title generator*, *character generator*, or *CG*) creates letters and numbers (*characters*) on a video signal that can be displayed on a television/monitor or recorded by a VCR.

What is the TitleMaker 2000?

The Video TitleMaker 2000 is a video titler with many additional capabilities. With TitleMaker 2000, you can:

- Create high-quality video titles over a solid color or patterned background, or *superimposed* (“*genlocked*”) over a video picture.

* The newsletter and other services are available for Videonics customers in the U.S. and Canada. Elsewhere, contact your Videonics distributor or retailer.

- Create and hold over 8000 characters of text, divided into hundreds of *pages*. Divide your pages into *projects*.
- Copy and move text, to revise titles without retyping.
- Position text anywhere on the page, including automatic centering.
- Choose from a wide variety of fonts and sizes.
- Choose different styles. You can change the letter spacing, make the letters bold, and add outlines or shadows to the titles.
- Apply a pattern and any of a million colors to titles, backgrounds, outlines, and borders.
- Use *transitions (fades and wipes)* to start or end each page of titles.
- Use *scrolls* and *crawls* to move titles on or off the screen.

Basic Applications

TitleMaker 2000 can be used in live or taped settings. Chapter 20, "Editing, Presentations, and Other Applications," describes these functions in more detail and explains how they are accomplished with the TitleMaker 2000.

- You can add titles as you copy or edit tapes. The original tape remains untouched — titles are added to the edited copy. TitleMaker 2000 works with VCRs and camcorders of all videotape formats. You can superimpose titles on live video or on colored backgrounds, using fades and wipes to transition between plain video and video with titles.

For example, you might start a basketball video with a solid color screen with the title of the video. The names of the players could scroll onto the background. Then the titles could fade away. As the players run onto the court, their names appear, superimposed over the image at the bottom of the screen. The last name fades away as play begins. A player makes a difficult basket and the crowd roars! The score appears over a wildly- colored, animated background pattern and scrolls off the screen as play continues.

- You can present a running slate of on-screen titles for display, video-DJ, point-of-sale, or "video-billboard" applications. You can place titles on top of colored or patterned backgrounds or on live or taped video material.

For example, a hotel has monitors in the lobby. A video describing the hotel's facilities plays. Meanwhile, information about the day's scheduled events are superimposed using the TitleMaker 2000 with messages like "Business Effectiveness Seminar: Ballroom G." At dinnertime, the hotel manager changes the titles to advertise the restaurant specials: "Prime Rib Special today in the Mezzanine Grill."

Another example is the use of TitleMaker 2000 for business presentations. Instead of using transparencies or charts, you can create titles, using the colors, backgrounds, effects, and other features to emphasize the important points and make the presentation dynamic and exciting. You can also use the superimpose feature

to combine the presentation with video footage, such as shots of a new product or of the factory sites.

Equipment

Your Video TitleMaker comes with:

- Power supply
- This manual
- Product registration card.

You may need to purchase cables to connect audio and video equipment to the TitleMaker. Your Videonics dealer can help you identify the cables you need.

Chapter 2 • QuickStart

Whether you're a video expert looking for just the basic steps or a beginner who wants instant gratification, this chapter will have you titling in minutes!

This chapter describes just the basics. Many features and applications are skipped or mentioned only briefly. For more information, or if you encounter problems, refer to the table of contents or the index to locate a more complete discussion.

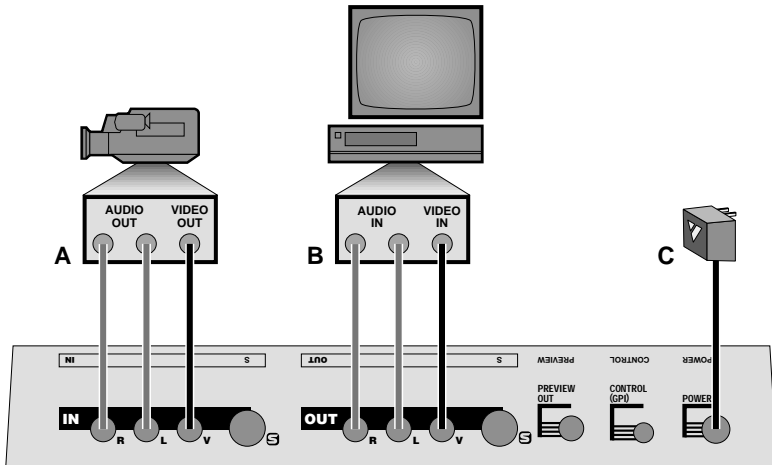

Typical TitleMaker 2000 connection

Connections

Connect the power supply (C) to a working wall outlet and connect the other end to the TitleMaker 2000's POWER jack. The POWER light comes on for a moment, then goes out.

Connect the TitleMaker 2000's OUT jacks to the VIDEO and AUDIO IN jacks of a VCR (B). Connect a television/monitor to the VCR in the normal fashion, so you can see the VCR's output. Leave the PREVIEW OUT jack unconnected unless you are using a PREVIEW monitor (Chapter 21). Turn the television and VCR on.

If you plan to superimpose titles over video, connect a camcorder, VCR or other source (A) to TitleMaker 2000's video and audio IN jacks. Turn on the video source and start the tape rolling.

Note: The illustration shows the use of composite (RCA-style) jacks for the video connections. You can use S-video (Y/C) jacks instead. It is important to use the same type of jacks for the input and the output. In other words, if your input is connected via the S-video jack, the output should also use S-video; if it uses the composite jack, the output should use composite too. An on-screen warning will alert you if you attempt to use the S-video output and composite input.

Note: The audio connections are for convenience only — the audio signals are not affected by the unit.

Power On/Off

POWER



Press POWER and the power light comes on. You should see a screen (called the Editing Screen) on the OUTPUT monitor, similar to the one in the illustration below.

Press POWER again to turn power off. Titles are retained in the TitleMaker 2000's memory even if the unit is unplugged.

When power is off, the OUTPUT monitor shows the video source that is plugged into VIDEO IN.

Note: When turning the unit off, be sure the power light is out before you unplug the unit.

Demo

Press the DEMO button to automatically demonstrate a range of features and effects. If no demo appears, check the connections. Press any letter key to stop the demo.

Instant Titles

Creating basic titles is simple. Start with the Editing Screen. The screen may not look exactly like this but it should have at least the blinking *cursor* (␣). Press POWER once or twice if the cursor is not displayed.

The cursor indicates where characters you type will appear. Page symbols (Σ, described later) separate pages of titles.

Type some titles. They appear at the cursor location. Press PLAY when you are finished. The Editing Screen disappears and the finished titles fill the screen. Congratulations — you have created your first titles! Press NEW LINE/OK to return to the Editing Screen.

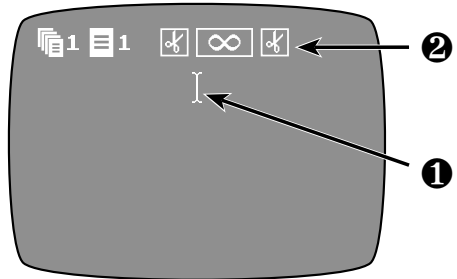

The Editing Screen

The Editing Screen and the Play Screen

You have just seen how the screen changes appearance, depending on whether you are creating titles or displaying them. The *Editing Screen* (the one with the cursor) is used to create or change titles. The *Play Screen* shows just the titles, with no cursor or other items. It is the screen you use to display and record the completed titles.

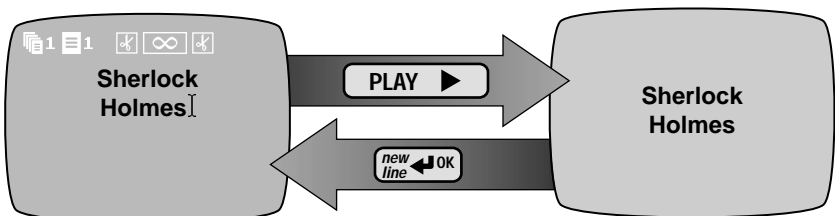

The PLAY key is used to go from the Editing Screen to the Play Screen. NEW LINE/OK (or any letter key) goes back to the Editing Screen from the Play Screen.

You can recognize the Editing Screen by the flashing cursor and the page symbols.

Pages



Titles are divided into *pages*. A page is a screenful of titles. You create a new page by pressing the NEW PAGE key. In this example, we typed "Sherlock Holmes," then NEW PAGE, then "221B Baker Street." That produces the following Editing Screen and Play Screens:

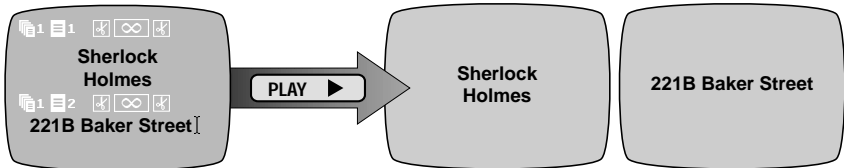

Page Symbols

A row of *page symbols* divides one page from the next. These are described in detail in Chapter 7. Briefly: The first two symbols and their numbers identify which page this is and to which project (described in Chapter 8) it belongs. The next symbols tell which effect will be used to introduce the page; how it will be displayed; and which effect will be used to end its display.

Projects

You can create separate *projects* (Chapter 8). Each project has its own pages which are protected from alteration while you are working on another project. This way several people can use the same unit, or one person can work on several distinct jobs.



The PAGE INDEX key is used to access projects. It lists all the pages in all the projects. By moving the cursor through the Page Index screen, you can begin work on any page, in any project. Press NEW LINE/OK to return to the Editing Screen.

Entering Text

To create a title, simply type some letters and they will appear at the cursor's location.

- To type a capital letter, hold SHIFT as you type. Press CAPS LOCK to cause all letters to be capitalized. Press it again to type in normal upper and lower case.
- To type special characters (such as the ones printed in gold on



the keys), press ACCENT and a letter at the same time. For instance, press ACCENT and Q to produce "ç."

- To type an accented letter such as "ö," simultaneously press ACCENT and the key with the desired accent mark, *then* press the letter to be accented. For example, press ACCENT and 2

together; then release them and press the A key. You will see the letter "ä."

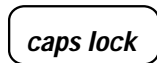

Lines

Press NEW LINE/OK to end the line of text and begin a new line.



Moving the Cursor

If you want to add text somewhere other than where the cursor is, use the arrow keys to move the cursor. Hold SHIFT as you press the UP or DOWN arrow keys to move a page at a time. SHIFT with the LEFT and RIGHT arrows moves the cursor to the start or end of the line.

Note: You cannot move the cursor past the end of the last line of text. If you want to type past the last characters on the screen, press NEW LINE/OK to create blank lines. The cursor moves down as you add lines. If you want to type past the last character in a line, position the cursor at the end of the line and type.

Editing the Text

To *insert* text, use the arrow keys to move the cursor to the desired location and type. New characters are added at the cursor's location.

To *delete* text, position the cursor after the characters you want to remove and press DELETE. The character before the cursor is removed. To delete large blocks of text at once, mark the text and press delete.

To *replace* text, delete the text, then insert.

Oops!

If you accidentally delete something, *immediately* press UNDO. It restores the text that was deleted by the last press of the DELETE key.

Using Menus to Change Colors, Fonts, etc.

You can change *characteristics* (such as fonts, colors and title styles) using the *menu keys* at the top of the keyboard. To do this, position the cursor anywhere in the line you wish to change and press the appropriate menu key.

For instance, press the LETTER COLOR button (in the top row). A menu of colors appears.

This menu has two *sub-menus* — one at the top of the screen (∂) and one at the bottom (π). Each sub-menu contains choices you can use to change your titles. The MARK START button is used to choose which sub-menu is active. In this example, the bottom sub-menu is active — if you wanted to use the top sub-menu instead, you would press MARK START.

One item in the active menu is highlighted. In this example, a color choice is highlighted by the triangular pointers (Π).

Use the *arrow keys* to move the highlight to a different color. The sample patch (Σ) shows the selected color. Press NEW LINE/OK or PLAY to choose the color you have highlighted. NEW LINE/OK returns you to the editing screen; PLAY plays the resulting page.

The characters in the line that contained the cursor change to the selected color.

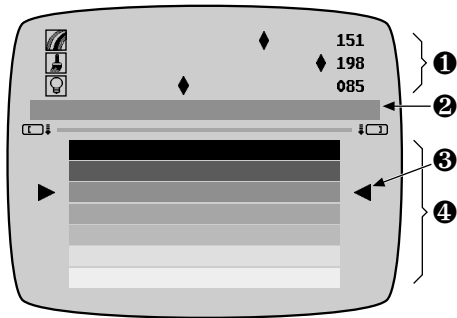

More Changes

Use menus to:

- Change font, style, size, letter color and pattern, background color and pattern.

- Add borders and change their type, color, and pattern.
- Use effects to start and end a page of titles.
- Make text scroll and crawl.

Each menu works the same way: If there are sub-menus, use MARK START to switch between sub-menus. Then use the arrow keys to highlight your choice and press PLAY or NEW LINE/OK to implement it.

Notes

- Background, Pattern, and Effect menus affect the entire page that contains the cursor. Other menus affect the entire line that contains the cursor. You cannot mix characteristics on a line.
- When you are editing text using the Editing Screen, several pages may be on the screen at once (with page symbols between them). Note that the backgrounds and borders of all the pages appear in the pattern and color of the page that contains the cursor. As you move the cursor from one page to another, the patterns and colors used in the entire screen will change. To see the patterns and color that are set for a particular page, move the cursor to that page.
- Each page can use one type of pixel pattern and one type of rainbow pattern (see Chapter 15). So, for example, if you set some letters to use rainbow pattern 11, then set the background to use rainbow 14, both will use 14.
- When you type something new, it will have the same characteristics as the preceding letter. If you want to type in a different style, use the menu key to make a new choice and continue typing.

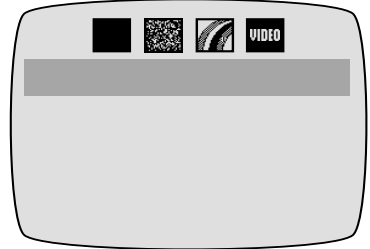

Superimposing Titles on Video

To superimpose titles on video, change the background pattern to VIDEO (rather than a solid color or pattern). Follow these steps:

- Position the cursor on the page that contains the titles you wish to superimpose.
- Press the BACKGROUND PATTERN menu button.
- Use MARK START to activate the top sub-menu. Use the RIGHT arrow key to highlight the VIDEO symbol. Press NEW LINE/OK.
- Confirm that your video source is running (start the VCR or camcorder).
- Press PLAY.

The OUTPUT monitor will show your page of titles superimposed over the source video:



Making Titles Come and Go

In a production, you may want superimposed titles to appear for a while, then disappear. To do this, place blank pages with video backgrounds between pages of titles.

Create a page of superimposed titles. At the end of the page, press NEW PAGE but don't type anything on this page. Set its background to VIDEO, if it isn't already. Press NEW PAGE again and type the next titles. When you play these pages, the first titles appear, then transition to the blank page. Since this page is empty and the background is plain video, the result is that the titles simply go away. The next page can then introduce more titles.

Positioning Text on the Line



You can change the position of the text on any line. A line can be centered or positioned against the left or right edge of the screen.

Position the cursor on the line. *Press and release* the POSITION key, then press the LEFT or RIGHT arrow. The line position changes immediately to show the new choice. (The page symbol is not affected.)

Positioning Text on the Page

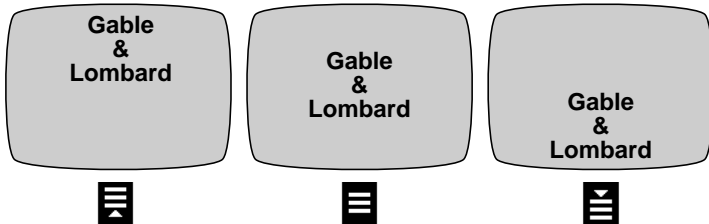

The page symbol shows how text is positioned on the page. It can be positioned at the top, center, or bottom of the page. To change the position, *press and release* the POSITION key, then press the UP or DOWN arrow on the arrow keypad.

Transitions, Durations, Scroll, and Crawl

You can determine how long each page will be displayed (its *duration*) and what *transition effects* (fade, wipe, etc.) will be used to introduce, and remove the page. You can also make titles *scroll* or *crawl* on or off the page.

Position the cursor anywhere on a page and use the EFFECTS IN menu key to change the page's duration, scrolling, speed, and the effect that will introduce it. Use the Effects Out menu to choose the effect that will be used to remove the page.

Duration is set using the bottom sub-menu of the Effects In menu. Highlight the digits after the clock symbol and type in the desired time. You can set infinite duration (displaying the page until you press PLAY again) by highlighting the infinity symbol.

Playing the Pages

When the pages are complete, move the cursor to the start of the first page and press PLAY. *Shortcut: To play all the pages in the project, press COMMAND + PLAY.* Each page will be displayed, in sequence, using the selected durations and effects. To play just some of the pages, play manually, etc., see Chapter 19.

Learning More

A convenient way to become a TitleMaker 2000 expert is to load the demo into the Editing Screen for study. To do this, press COMMAND + SHIFT + COPY at the same time (COMMAND + SHIFT + MOVE for the international demo) and the unit will create a new project that contains the demo text. This allows you to see how the demo was created.

More...

Refer to the index and table of contents to find detailed sections which explain how to:

- Create "projects."
- Move between pages or projects.
- Use the Page Index.
- Use a PREVIEW monitor to change titles out of the audience's view.
- Add borders, lines, and boxes to your video pages.
- Mark large blocks of text so you can move or copy them without typing.
- Use effects (such as wipes) between pages and set durations so pages are displayed for a pre-defined time.
- Combine scroll and crawl to move titles on and off the screen in many different ways.
- Play pages in many ways, such as manually, backwards, automatically repeating, etc.
- Use TitleMaker 2000 with editing equipment.
- Copy and move large sections of text.
- Choose colors and define your own colors.
- Create transparent background patterns and colors.

Chapter 3 • Connections

Connections: Overall Concept

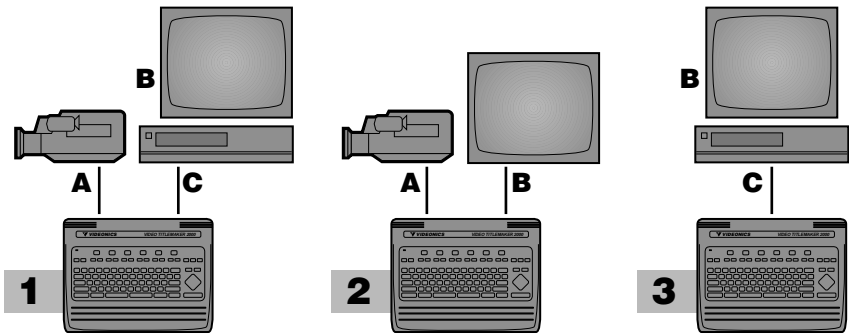

The first diagram (1) shows a typical video production setup. The TitleMaker 2000 is connected between a *video source* (A), which plays the picture to which you will add titles, and a *recorder* (C), which will record the results. Some common variations:

- 1 The diagram shows a camcorder (A) as the video source. Other sources, such as a VCR or camera can be substituted.
Hint: You can leave the unit permanently connected. When the power supply is plugged in but the power light is off, the input signal is passed through to the output and no titles are added.
- 2 The output can be connected directly to a monitor (B), instead of going through a VCR, if you plan to display titles without recording them.
- 3 The source is optional — the TitleMaker 2000 can operate without a source, generating titles on its own backgrounds.

This chapter describes how to connect the inputs, outputs, and monitors. Chapter 4, "Connecting Editing Equipment" goes further, explaining how to attach editing equipment, such as an edit controller, video mixer, video processor, or effects unit.

What You'll Need

A Video source (optional). Any standard video source with composite (RCA-style) or S-video (Y/C) outputs can be used, including VCRs, camcorders, cameras, video disc players, video production equipment (such as a mixer, processor, or another titler), and computers with television outputs. If no source is used, the TitleMaker 2000 will create titles on its own backgrounds.

- B An OUTPUT monitor.** The monitor will be connected to a recording VCR in most cases. Required connections depend on the VCR. You can use any arrangement that will allow you to view tapes played on the VCR.
- C A Record VCR.** In a live setup, in which the results will be displayed without being recorded, the VCR is optional, but most setups will include the VCR.
- D PREVIEW monitor (optional).** If used, this monitor must have a composite (RCA-style) video input. Use of the PREVIEW monitor is described in Chapter 21, "Preview."
- **Video Cables.** You will need one video cable to connect the output to the Record VCR and one to connect the Record VCR to the OUTPUT monitor. You may also need a cable for the input, if a video source is used; and for the PREVIEW monitor, if used. The next section describes the types of cables.

Types of Input and Output Jacks

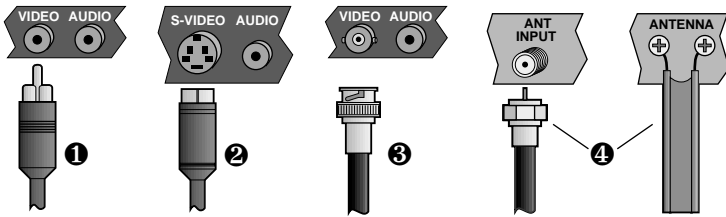

∂ Composite (RCA-style) video and audio

Σ S-video (Y/C)

Π BNC video, used in some professional equipment

π RF cables (Coaxial cable and twin-lead antenna cable)

- Note: European video equipment often has SCART plugs. Adapters are commonly available to connect SCART-equipped units to the RCA jacks provided on the TitleMaker.

Audio

RF cables carry the audio signal along with the video. All the others require a separate RCA-style audio cable.

Types of Cables Used with the TitleMaker 2000.

- **INPUT and OUTPUT.** You can use S-video (Y/C) or composite (RCA-style) jacks for the input and output. S-video (Y/C) jacks will deliver somewhat better performance than composite (RCA-style) jacks, but only if they are used for *both* the input and

output. In other words: Use S-video (Y/C) jacks if your source and recorder are both equipped with them; use only the composite (RCA-style) jacks if either lacks S-video jacks.

If you are using the S-video output jacks, you *must* use S-video for the input. If you try to use the S-video output and the composite (RCA) input, an on-screen warning appears to remind you to use S-video in.



- **Record VCR to OUTPUT monitor.** If you are using a Record VCR, the OUTPUT monitor can be connected to the VCR using an RF (antenna/cable type) cable, composite (RCA-style) cable, or S-video (Y/C) cable, depending on what types of jacks are available on the VCR and monitor. If you have a choice, S-video is generally better than composite and composite is better than RF.
- **PREVIEW.** If you are using a PREVIEW monitor, it must be connected via a composite (RCA-style) cable.
- **BNC.** If you plan to use equipment with BNC jacks, you will also need RCA-BNC adapters.
- **Audio.** The audio jacks on the TitleMaker 2000 are simple pass-through connectors, provided to make connections between two video devices convenient. AUDIO IN is routed directly to AUDIO OUT, unmodified by the unit.

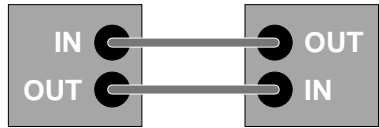

IN and OUT Markings

Hint: Always connect the OUT jack of one device to the IN jack of the next. Never connect two OUTs together.

Connection Diagram

This diagram shows the connections for a typical titling setup. The sections that follow provide detailed instructions.

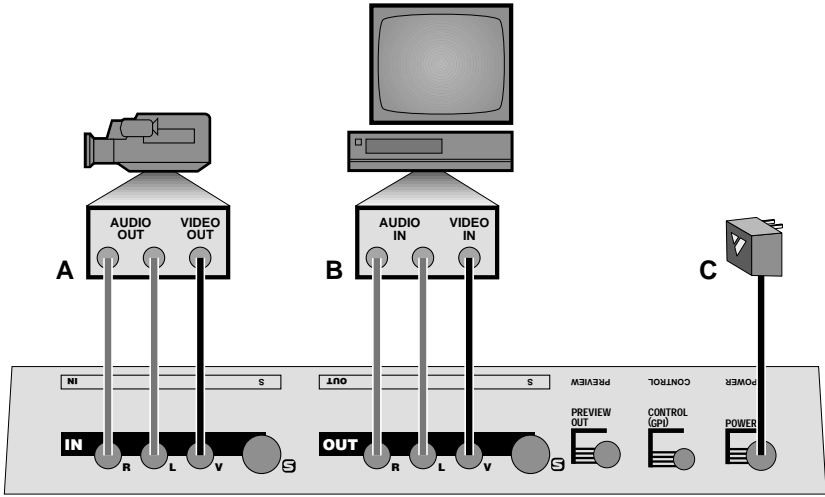

Connecting Power

- Connect the power supply (**C**) to the POWER input and plug it into a working power outlet. Be sure to use the power supply that came with the unit. **Others, including the ones supplied with other Videonics products, may damage the unit and void the warranty.**

As soon as the power supply is connected, the power light on the front panel comes on for a moment, then goes out.

Turning Power On and Off: Video Pass-Through and Data Protection

- To turn the unit on or off, press the POWER button. The front panel light indicates whether the power is on.

Notes:

- When the unit has been connected to the power supply for a while, it will be warm to the touch. The power supply will also be warm. This is normal.
- When power is off, video is routed from the video input to the video output and no titles are added. This eliminates the need to disconnect the unit when titles are not needed — you can simply turn the unit off and video is passed straight through.

- **To assure reliable storage of titles, always press POWER and be sure the power light is out before you unplug the power supply.**

Here’s why: Titles are retained by the built-in lithium battery when you turn the power off. Even when the unit is unplugged, all titles remain intact, including all settings and formatting. When you turn the unit off, the TitleMaker 2000 reorganizes its memory to optimize storage. It is important not to unplug the unit until the light turns off, telling you this operation is complete.

Connecting Outputs and Monitors

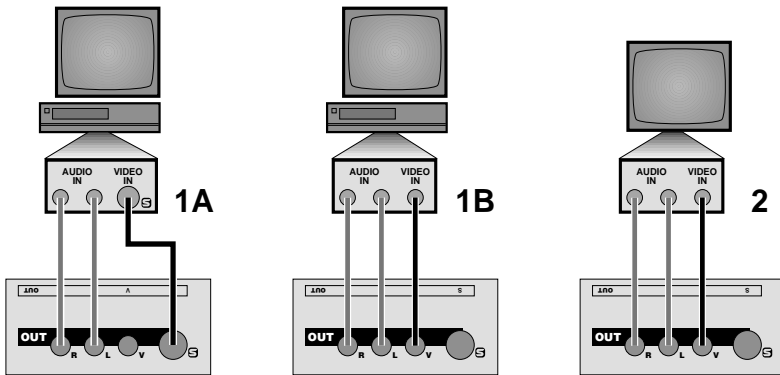

Example Output Connections

- Connect the OUTPUT monitor to the TitleMaker 2000’s video OUT jacks:
- **1A, 1B: If you will be recording the output** (as in a video production setup), connect the TitleMaker 2000 video OUT to the VIDEO IN of the Record VCR. Then connect a television or monitor to the Record VCR, as described in the manual that came with the VCR.

You can use either S-video (Y/C) cables (**1A**) or composite (RCA-style) cables (**1B**) to connect the TitleMaker 2000 to the VCR. You can use S-video, composite, or RF (cable/antenna) cables to connect the VCR and the television/monitor.

In either case, connect the TitleMaker 2000 audio OUT jacks (marked L and R) to the Record VCR’s AUDIO IN.

- **2: If you will not be recording the output**, connect the TitleMaker 2000 video OUT to the VIDEO IN of a monitor. You can use S-video (Y/C) or composite (RCA-style) cables for this connection. If you are using a television with no VIDEO input (that is, it has only an RF (cable/antenna) jack, you will need a VCR or an “RF modulator” to connect the TitleMaker 2000 to it.

Connect the TitleMaker 2000 audio OUT (marked L and R) to the monitor’s

AUDIO IN or to an external amplifier and speakers.

- Set the OUTPUT monitor’s input switch.
- Important:** If the television/monitor you are using has an input selection switch, set it so it is displaying the correct input. For instance, if you have connected to the monitor’s VIDEO 1 input jack, you would choose VIDEO 1 as your input. Refer to the manual that came with your monitor for details.
- Set the Record VCR input.

Important: Set the VCR’s controls so that it will record whatever comes into its VIDEO IN jack, rather than recording a broadcast channel. Different VCRs use different methods to do this. Your VCR’s manual should explain how, probably in a section that discusses copying tapes from a camcorder. Here are some common examples:

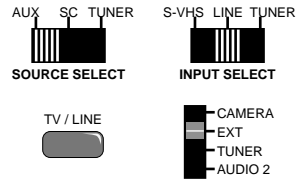

- Most VCRs have an *input selector* switch that goes between LINE (or AUX, EXT, A/V, or S) and TUNER. The illustration shows some examples.
- Some use a button on the remote control or an on-screen menu to choose an external line source.
- Others require that you choose a special channel (like 99 or A1).
- Still others switch automatically when you plug the cable into the VIDEO IN jack.
- Test the connections.

Turn the TitleMaker 2000, VCR, and television on and press DEMO. You should see a series of titles with various transitions between them. Press DEMO again to stop the demo.

- CONTROL (GPI).

The CONTROL (GPI) input allows the unit to be triggered by edit controllers equipped with GPI (“General Purpose Interface”). It is described in Chapter 20, “Editing, Presentations, and Other Applications.”

- Optional: Connect the PREVIEW monitor.

Note: See Chapter 21 to determine whether you need a PREVIEW monitor.

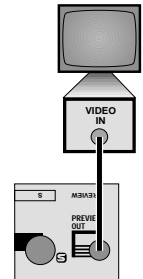

Important: Leave the PREVIEW OUT jack unconnected if you are not using a PREVIEW monitor. Connecting anything, even an unconnected plug, to this jack enables preview mode. In Preview mode, the Editing Screen is not displayed on the OUTPUT monitor.

Connect the TitleMaker 2000’s PREVIEW OUT to the VIDEO IN jack of the PREVIEW monitor using a composite (RCA-style) cable. (If the monitor

only has an RF (cable/antenna) jack, you will need a spare VCR or an RF modulator to convert the RCA-style output to RF.)

- Test the PREVIEW connection (if used).

Turn the PREVIEW monitor on. Press DEMO. You should see a series of titles.

- Optional: Align video output.

Television screens do not normally show the entire picture. A small amount of each edge is normally cut off. The amount that each edge cuts off can vary, making the image slightly off center. For normal television viewing, this is not very important but titles tend to make an imbalance noticeable. TitleMaker 2000 allows you to adjust the picture to center it on the screen.

To adjust the centering, press SHIFT + POSITION. A large rectangle is displayed. Use the arrow keys to adjust the rectangle until it is centered and press NEW LINE/OK. The new centering will be remembered even if you unplug the unit.

You can re-center the image, bringing it back to the original factory setting, by pressing SHIFT + POSITION again while the rectangle is displayed.

Connecting a Video Source

Video sources include camcorders, VCRs, laserdisc players, cameras, video production equipment (such as a mixer or another titler), satellite tuners, broadcast tuners/receivers, video-equipped computers, etc. They may have S-video (Y/C) or composite (RCA-style) output jacks. RF sources (cable TV, antenna, "channel 3/4," or other modulated sources) must be converted to S-video or RCA-style format video using a tuner, television, VCR, etc.

- Connect the video source's VIDEO OUT jack to the video IN jack on the TitleMaker 2000. Connect the source's AUDIO OUT jacks to the TitleMaker 2000's AUDIO IN jacks.

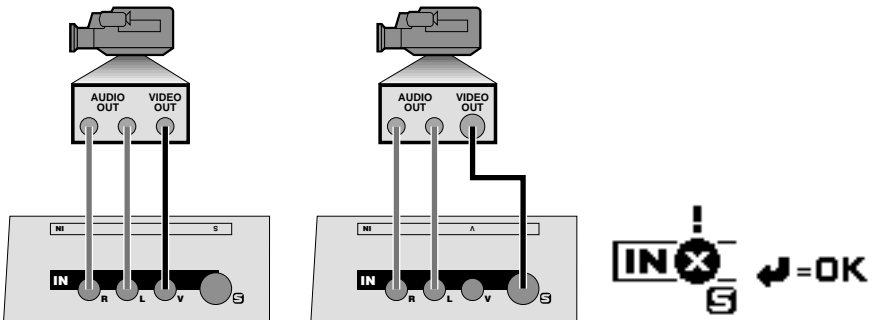

Input Connection Examples

Avoid mixing input and output types — if S-video jacks are not available on both the input and output, use composite for both. If you try to use the

S-video output and the composite (RCA) input, an on-screen warning appears to remind you to use the S-video input.

- Test the input connections.

Press POWER to turn the TitleMaker 2000 off. The input video is passed through to the output, so you should see the input video on the OUTPUT monitor.

Troubleshooting Hints

If you do not see the picture you expect, review the following hints:

- Confirm that the POWER light is on.
- Double-check the connections, especially the one from the TitleMaker 2000's VIDEO OUT to your monitor or VCR's VIDEO IN. Most problems are caused by a cabling mistake.
- Be sure the television is set to monitor the video input you are using rather than, say, channel 7 (see "Set the OUTPUT monitor's input switch"); and that the VCR is set to record its video input (see "Set the Record VCR input"). This is the second most common cause of problems.
- Check the obvious. Is everything turned on, are all switches set correctly? Are all connections correct, with OUTs going to INs?
- If you see titles when you press PLAY but you never see the screen with the cursor, confirm that there is nothing — not even an unconnected cable — plugged into the PREVIEW OUT jack.
- Try swapping cables — if the problem changes when you completely exchange two cables, you may have a bad cable.
- If you are using S-video connectors, try temporarily using the RCA connectors instead.
- Jumpy or off-color recordings are often caused by poor quality originals or by the use of commercially recorded videos as the source material. Many recordings carry copy-protection signals designed to prevent copying. The TitleMaker 2000 is not designed to remove copy-protection signals.

Chapter 4 • Connecting Editing Equipment

The TitleMaker 2000 is compatible with a wide range of editing equipment, such as edit controllers, video processors, and video mixers. It can be connected in a variety of ways, depending on what you plan to do and what equipment you have.

A title generator is a common part of a video editing setup. This chapter describes how to connect editing equipment to the TitleMaker 2000. For information on how to edit using the TitleMaker 2000, see Chapter 20, "Editing, Presentations, and Other Applications."

Hint: Verify that the basic connections, described in the previous chapter, are working properly before you add advanced equipment.

Concept

There is no single, "correct" way to connect equipment in an editing studio. The setup varies, depending on what you want to accomplish. The most important concept is that editing equipment is connected in a chain, with the output of one device feeding the input of the next.

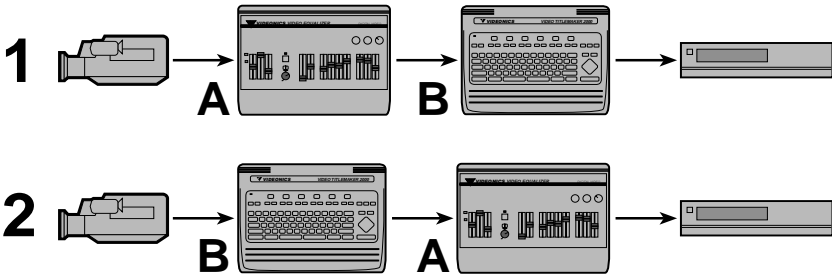

The order in which the pieces of equipment are connected matters since each piece will act on the video generated by devices that are earlier in the chain. For instance, if you wanted to add titles to video that has had special effects added, you would use the setup labeled 1 in the illustration, connecting the titler (B) after the special effects unit (A). If you wanted to add effects to the titles and the video, you would reverse the order, as in setup 2.

Videonics Equipment Arrangements

Here are some recommended setups using Videonics equipment.

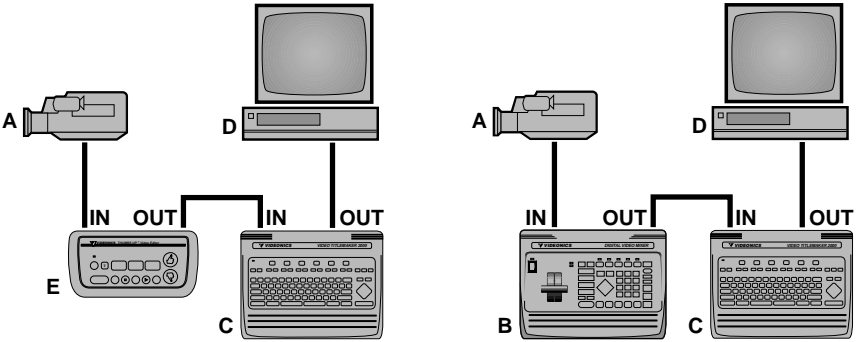

In the first setup, the camcorder (A) is connected through Thumbs Up (E) and the TitleMaker 2000 (C) to the recorder (D). In the second setup, the camcorder (A) is connected through a Digital Video Mixer (B) to the TitleMaker 2000 (C) and it is connected to the recorder (D).

Note that other hookups may be more suitable for your setup, as explained in the rest of this chapter.

Single-Source Editing Setup

A *single-source* editing setup uses a camcorder or VCR (player) to play scenes from an original tape. The desired scenes are recorded on a blank tape, leaving the unwanted scenes behind. An *edit controller* may be used to control the player and trigger the recorder for accurate edits.

The TitleMaker 2000 can add titles as the scenes are recorded on the new tape. To do this, the titler is connected between the player and the recorder:

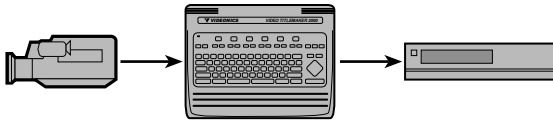

When an edit controller is used, the titler may be used between the edit controller and the player, or between the edit controller and the recorder. Either arrangement is likely to work unless the edit controller relies on information that is coded in the invisible portions of the video signal (vertical interval time code, or VITC). If that is the case, the titler may interfere with the time code when titles replace the incoming video. Follow the instructions in the edit controller's manual. If there are no instructions, connect the TitleMaker 2000 between the edit controller and the recorder:

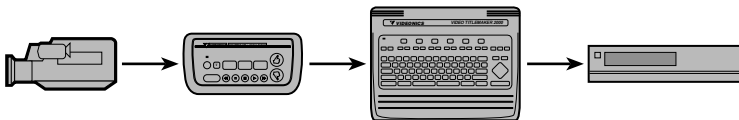

If you experience problems with this setup, connect the TitleMaker 2000 between the player and the edit controller instead.

Use with Video Processors

A *video processor* or *enhancer* may be used as well. Processors are generally connected directly to the camcorder output so they adjust the video before titles are added.

Multiple Source Editing with a Video Mixer

Advanced editing combines video from more than one source. A *video mixer* is used to combine the video sources to use fades, wipes, and other effects to transition between sources. As with a single source, you can connect a titler before or after the mixer:

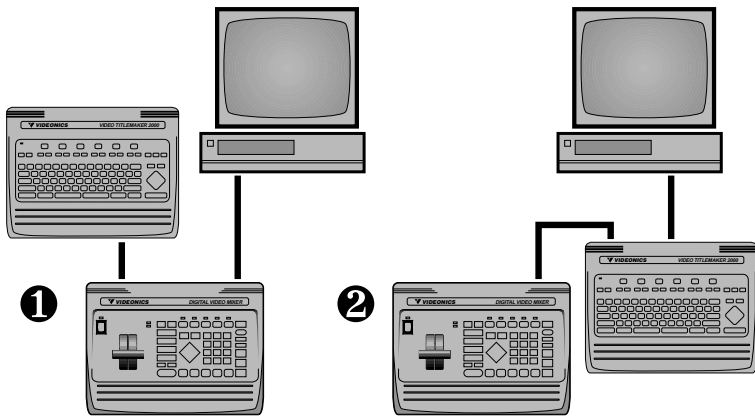

Generally, the most flexible arrangement is to connect the TitleMaker 2000 between the mixer and the recorder (Σ). This arrangement has an important advantage: Titles can be superimposed over the mixed signal. For instance, you could have a wipe from source B to source C and have titles superimposed over the entire transition, rather than just having the titles atop either B or C.

You may use the titler as a separate input (∂). The advantage of this arrangement is that the mixer’s effects can be used on the titles.

Of course, you can use multiple TitleMaker 2000s, connecting one titler to the input and one to the output.

GPI Control

The TitleMaker 2000 is equipped with a CONTROL input. As explained in Chapter 20, “Editing, Presentations, and Other Applications,” this allows you to set up pages of titles, with pre-defined durations and effects, and have an external controller trigger each new page as the production is assembled. Edit controllers such as Videonics Thumbs Up are equipped with a GPI (“General Purpose Interface”) output that will trigger the TitleMaker 2000.

Warning: Always turn off power before plugging anything into GPI jack.

GPI Cable

A special cable is required. You can buy a Thumbs Up-to-TitleMaker GPI trigger cable from Videonics (part number CBLA-0034-01) or you can buy or make your own. The cable has a stereo male 3.5 mm sub-mini-plug at each end and three wires connect each terminal of one plug to the corresponding terminal of the other.

For other controllers, you will have to make your own cable using a stereo male 3.5 mm sub-mini-plug at one end. Wire the “tip” and “base” (not the middle “ring”) to the two wires of your GPI trigger source.

You can also wire a pushbutton switch to the GPI input to remotely trigger titles, as described in Chapter 20.

Chapter 5 • Using the Demo

The built-in demo is a convenient way to learn what the unit can do.

Using the Demo

To display the TitleMaker 2000's built-in demo, turn the unit on and press the DEMO key. The OUTPUT monitor will display a series of titles that describe the unit's features and applications and demonstrates the kind of effects you can generate. Press any key to end the demo.

Running the demo does not erase any titles you have entered.

International Demo

Press SHIFT + DEMO to display a demo that minimizes the use of English language text. This demo is designed for international use.

Locked Demo

Normally, pressing any key will end the demo. If the demo is running in a display and you want to prevent passers-by from accidentally ending the demo, hold COMMAND as you start the demo (COMMAND + DEMO for the English language demo; COMMAND + SHIFT + DEMO for the international version). This will start a locked demo. Only the COMMAND + DEMO or COMMAND + SHIFT + DEMO key combination will stop it.

Using the Demo as a Guided Tour

The demo makes extensive use of TitleMaker 2000's features and includes several clever tricks for making interesting titles. You can study the demo in detail by copying it into the Editing Screen. To do this, press COMMAND + SHIFT + COPY. This creates a new project which contains the English-language demo. (You can copy the international demo by pressing COMMAND + SHIFT + MOVE.) You can then use the cursor to tour the demo. You can view the menu settings used on any line. Position the cursor in the line, press each menu key, and observe the settings.

Note that the demos are quite large and it is a good idea to delete all unneeded titles before copying a demo in. If the memory warning symbol appears when you attempt to copy the demo, it means memory is full. Part of the demo may have been successfully copied but you will have to delete some text before you can copy the whole demo.

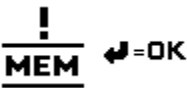

Using the Demo to Create Titles

Instead of creating a new set of titles from scratch, you can start with the demo as raw material. To do this, copy the demo into the Editing Screen as described above. Delete pages and modify text to create your own titles. This is often faster than creating new material from scratch.

Chapter 6 • Typing Titles

Creating titles is as simple as typing with the TitleMaker 2000's full keyboard with upper and lower case, plus special and accented characters.

The Editing Screen and Cursor

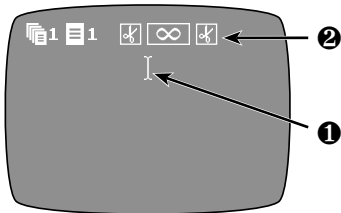

the number of the page (B), the belongs (A), the effects that will be used to start and end the page (C and E) and how long the page will be displayed (D). These items are described in detail in Chapter 7, "Pages."

The *Editing Screen* is used whenever you are typing or editing text.

New text always appears at the blinking cursor (∂). New letters are always inserted — they don't replace letters already on the screen.

The *page symbols* (Σ) indicate where a new page of text begins. They also tell you number of the project to which the page

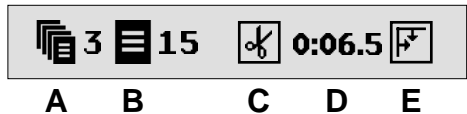

Moving Around the Screen

Use the *arrow keys* to position the cursor.

Note: You cannot move the cursor past the end of the text. If you want to add some new text at the bottom of the screen, past the last character, use the NEW LINE/OK key to add some blank lines and move the cursor to the bottom of the screen. Or position all of the page's text at the bottom of the screen using the POSITION key (Chapter 10).

If there is more than one screenful of text, you can move to the next or previous screen by using the UP or DOWN arrow to go beyond the top or bottom line on the screen — the pages will scroll to keep the cursor in view. The cursor will stop when it reaches the top of the first page or the bottom of the last page.

Shortcuts for Moving the Cursor

Hold SHIFT while you press the RIGHT or LEFT arrow key and the cursor will jump all the way across the screen, in the direction of the arrow you press. If you hold SHIFT while you press the UP or DOWN arrow key, you will move forward or back a page at a time.

Hold COMMAND while you press the UP arrow to go to the top of the first page of text; use COMMAND-DOWN arrow to go to the end of the last page.

You can move between projects (explained in Chapter 8) by pressing COMMAND and SHIFT as you press the UP or DOWN arrow.

Modifier key	LEFT or RIGHT arrow	UP or DOWN arrow
SHIFT	Next start or end of line	Start or end of next page
COMMAND	Next start or end of line	Start or end of current project
COMMAND + SHIFT	Next start or end of line	Start of previous or next project



Typing Titles

To create a title, simply type the letters. They appear at the cursor's location. You can change the color, style, size, etc. as you go or you can type all the text and change the way it looks later.



- Use the NEW LINE/OK key to end a line of text and begin another line. You can type up to 1000 characters per line. (It's unlikely you would ever try to type that many but if you do, the memory-full symbol appears to remind you to start a new line.)

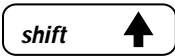

- If you make a mistake, use the DELETE key to erase the last letter.



- To type capital letters, hold the SHIFT key as you type the letter. The SHIFT key also provides punctuation marks such as "!" and "&."
- If you want something in all capitals ("Our trip to NEW YORK CITY"), you can use the CAPS LOCK key. Press it once and all your typing will be in capitals; press again to type lower case letters. CAPS LOCK doesn't affect the number keys or punctuation marks; you must use SHIFT for those characters, even when CAPS LOCK is on. Note that there is no indication that CAPS LOCK is on other than the fact that letters you type are capitalized.

- Some fonts have only capital letters and produce capital letters with or without SHIFT or CAPS LOCK.

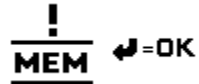

- The space bar is in two halves. Each creates a space character; there is no difference between the two halves.
- If this symbol appears when you type, memory is full or the line or page is full. You will be unable to add more text unless you erase other text. Press COMMAND + M at any time to see how much memory is left.

Columns (Tabs)

The TAB key is a “smart tab,” designed to make it easy to create columns of information. It works by aligning with the next blank space in the previous line of text.

Example: Type a line of text, using spaces to separate the words:

Name Age Address

Now press NEW LINE/OK and type a second line, using the TAB key between words. Each TAB will cause the next word to begin where a word above it begins:

Name Age Address
Jules 11 1406 Windmere

You may need to make adjustments. For instance, if a word aligns itself to the wrong blank space, you may need to add more TABs. You can also add and remove spaces and blank lines to adjust the appearance.

Notes:

- When you add a tab to a line, the line is automatically left-positioned (as if you had pressed POSITION followed by the LEFT arrow).
- Tabs are not automatically adjusted when you edit a line. You may need to add tabs or spaces to realign the columns.
- Tabs are based only on the line immediately before the line that contains the cursor.

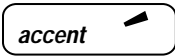

Typing Special and Accented Characters

TitleMaker 2000 includes special characters, such as • and ©, and accented characters to support many languages. Most of them are indicated on the keys, in gold. There are a few pictorial characters which are not printed on the keys. Use the special character listing on the following pages to find them.

The ACCENT key, at the lower left corner of the keyboard, is used to type special and accented characters:

- To type special characters, simply press ACCENT while you press the desired character. For instance, press ACCENT and Y together to type the “©” character. SHIFT is used, in some cases, to type the capitalized version of the special character.
- Accented letters, such as é and ñ, are typed by combining the accent mark with the letter. The accent is typed, followed by the letter.

The charts on the next pages show all the accented and special characters and how to type them.

SPECIAL CHARACTERS

In the following list:

- “+” indicates that keys are pressed together; you don’t press the “+” key.
- Capital letters are used for clarity; you don’t press SHIFT unless it is indicated.

Character	Keys	Notes
ç	ACCENT + C	
Ç	ACCENT + SHIFT + C	
æ	ACCENT + A	
Æ	ACCENT + SHIFT + A	
œ	ACCENT + O	Press the letter O, not the number 0.
Œ	ACCENT + SHIFT + O	Press the letter O, not the number 0.
ø	ACCENT + 0	
Ø	ACCENT + SHIFT + 0	
ß	ACCENT + S	
§	ACCENT + D	
«	ACCENT + [
»	ACCENT +]	
ı	ACCENT + 1	
ı̇	ACCENT + /	
¢	ACCENT + Q	Cents
£	ACCENT + W	Pound
¥	ACCENT + E	Yen
®	ACCENT + R	Registered trademark
™	ACCENT + T	Trademark
©	ACCENT + Y	Copyright
°	ACCENT + 7; SPACE	Degree **
•	ACCENT + U	Bullet
—	ACCENT + -	Long “(em)” dash *
‘	ACCENT + ;	Left curled single-quote *
’	ACCENT + ’	Right curled single-quote *
“	ACCENT + ,	Left curled quote *
”	ACCENT + .	Right curled quote *

* Note: TitleMaker 2000 offers “curly” quotes in addition to “straight” quotes. Curly quotes look like this: “ ” ‘ ’, as opposed to straight quotes which look like this: " ". It also has the “em-dash” (—), a dash that is longer than a hyphen (-). Note that the straight quotes in some fonts are actually slightly curled due to the style used by that font’s designers.

** For the degree symbol, type ACCENT + 7 *followed by* SPACE.

The following characters are not printed on the keypad.

← ↓ ↑ →	ACCENT + 	Arrows
♥	ACCENT + F	Heart
✓	ACCENT + G	Checkmark
★	ACCENT + H	Star
◆	ACCENT + J	Diamond
■	ACCENT + K	Square
□	ACCENT + L	Open box

ACCENTED (LANGUAGE) CHARACTERS

The accents above the 2, 3, 4, 5, 6, and 7 keys are used *with other letters* to make accented letters. For instance, to type ü, you would use ACCENT + 4, followed by the letter U. The capitalized version (Û) would be displayed using ACCENT + 4, followed by SHIFT + U.

In this list, "letter" means the letter you want accented.

To Type:	Press:	Then press:
´	ACCENT + 2	SPACE
á, é, í, ó, ú	ACCENT + 2	letter
Á, É, Í, Ó, Ú	ACCENT + 2	SHIFT + letter
˘	ACCENT + 3	SPACE
à, è, ì, ò, ù	ACCENT + 3	letter
À, È, Ì, Ò, Ù	ACCENT + 3	SHIFT + letter
¨	ACCENT + 4	SPACE
ä, ë, î, ö, ü	ACCENT + 4	letter
Ä, Ê, Î, Ö, Ü	ACCENT + 4	SHIFT + letter
˜	ACCENT + 5	SPACE
ã, õ, ñ	ACCENT + 5	letter
Ã, Õ, Ñ	ACCENT + 5	SHIFT + letter
ˆ	ACCENT + 6	SPACE
â, ê, î, ô, û	ACCENT + 6	letter
Â, Ê, Î, Ô, Û	ACCENT + 6	SHIFT + letter
˚	ACCENT + 7	SPACE
â	ACCENT + 7	letter a
Â	ACCENT + 7	SHIFT + letter a
"	ACCENT + 8	SPACE
ˆ	ACCENT + 8	letter
ô, û	ACCENT + 8	letter
Ô, Û	ACCENT + 8	SHIFT + letter

Chapter 7 • Pages

Titles are displayed as pages. Each page is played one at a time. A variety of effects can be used to play the pages.

About Pages

The TitleMaker 2000 will hold over 8000 characters. They can be divided into *pages*. The Play Screen shows one page at a time.

Text can be divided into new pages anywhere you like. For instance, you could have simple subtitles, each on a different page, resulting in 100 pages, each with just a few characters. Or you might have a few long pages, each scrolling up the screen.

Long Pages

Text that is typed past the edges of a page is not erased. When you move the cursor past the edge of the screen, the invisible text scrolls into view.

If you play a page that has text past the edge of the screen, the extra text will not be displayed. You can edit the page to show the extra text: Break the line into smaller pieces; use a smaller font, size, or style; or use a scroll or crawl effect.

- There is no fixed limit on the number of pages or on the number of characters that can be typed on a page.
- A line can contain up to 1000 characters. If you type beyond the 1000 character limit, the memory warning symbol appears.
- Scrolling pages are limited to 40-60 lines, depending on the number of characters in the line. The memory warning symbol appears if you attempt to play a page that scrolls too many lines.

Creating a Page

Use NEW PAGE to start a new screen. For example, type "Sherlock Holmes," then press NEW PAGE, then type "221B Baker Street." You will see something like this:

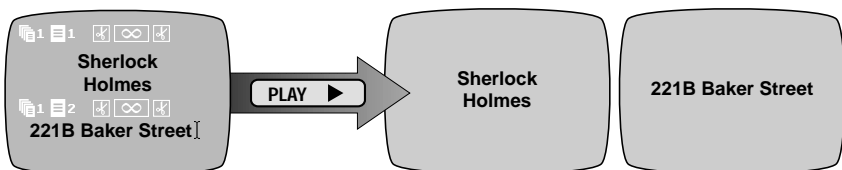

"Sherlock Holmes" is on one page and "221B Baker Street" is on the next.

Page Symbols

A set of *page symbols* starts each page:

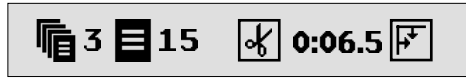

- The first symbol (**A**) indicates the current project (described in the next section). The number indicates the number of the project to which the page belongs.
- The second symbol (**B**) indicates the number of the page within the project. It also shows the vertical positioning of the text on the page. The symbol changes depending on whether the text is positioned at the top, bottom, or center of the page.
- The next symbol (**C**) shows the EFFECT-IN that has been selected. This effect will introduce the page when it's played.
- The next symbol (**D**) shows the duration of the page — how long it will be displayed when you press PLAY. If the page is set for infinite duration, scroll, or crawl, a symbol is displayed here instead of a number.
- The last symbol (**E**) indicates the EFFECT-OUT.

Navigating Pages and Projects with the Page Index

With the ability to create hundreds of pages comes a problem: How do you find a particular page efficiently? TitleMaker 2000 includes a *Page Index* that lists all pages in a condensed form and makes it easy to move the cursor to the desired page.

Press PAGE INDEX and a Page Index screen appears.

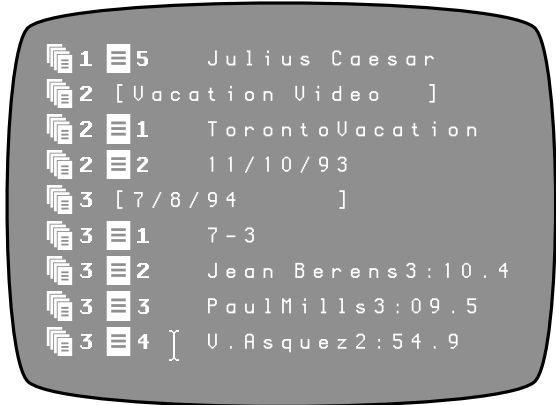

Each page appears as a single line beginning with the project symbol, the project number, the page symbol, and the page number. The rest of the line contains as much of the text from the page as will fit.

All pages and all projects are listed in order. The cursor shows the current page. Use the arrow keys to find any page. As in the Editing Screen, you can move quickly through the pages. Hold SHIFT while you press the arrow keys and the cursor will jump a screenful at a time. Hold COMMAND while you press arrow to move between projects.

Press NEW LINE/OK to exit the Page Index and return to the Editing Screen.

Deleting a Page

To delete an entire page and its contents, use the Editing Screen to locate the page. Position the cursor after the very last character of the previous page and press MARK START. Position the cursor after the last character of the page you want to delete and press MARK END. (This marks the entire page, including the page symbols at the page's start.) Press DELETE. Remember that as a safeguard, in order to delete marked text, the cursor must be located just after one of the marks.

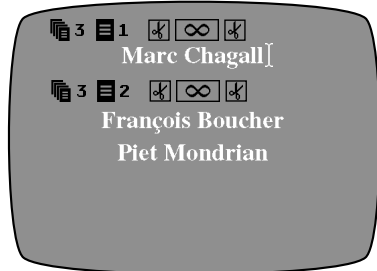
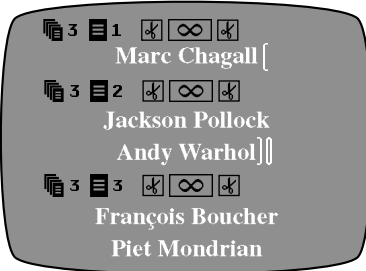

If an entire page is marked, DELETE will erase page and its contents.

To delete a set of page symbols (merging the two pages), don't mark any text. Position the cursor just before the first character after the page symbols and press DELETE. The page symbols will be deleted and the pages will merge. The page characteristics (background color, effects, etc.) of the page that preceded the symbols will be applied to the new combined page.

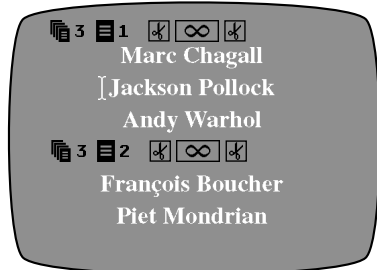
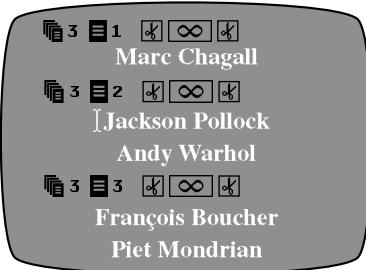

If nothing is marked, deleting just the page symbol line will merge the two pages.

If you delete something accidentally, remember that UNDO restores the last thing you deleted as long as it is pressed immediately after the deletion.

Inserting a Page

To add a new page, or divide a page into two pages, position the cursor at the desired location and press NEW PAGE. A new set of page symbols will appear at that point and the new page will inherit the characteristics of the page before it. You can then change the characteristics of either page.

Moving and Copying Pages

You can move or copy entire pages. Mark all the text on the page, *including the page symbols*. In other words, position the cursor at the very end of the page before the one you want to copy or move and press MARK START; position it at the end of the page and press MARK END. Then move the cursor to the desired location and press COPY or MOVE.

Chapter 8 • Projects

You can set up separate titling projects. Each project is stored independently and can be changed without affecting other projects.

About Projects

With its ability to hold over 8000 characters and retain them even when power is disconnected, the TitleMaker 2000 can hold the titles for many different titling tasks at once. *Projects* provide a convenient way to keep each job's titles separate.

A project is simply a collection of pages. Each project is independent — you can make changes in one project without the danger of accidentally erasing or changing titles that are in another project. Projects can have any number of pages or text characters and there is no limit to the number of projects. You can have many small projects, one large one, or anything in between. Projects can be named to make it easy to remember which project is for each use.

Examples of How Projects are Used

- Projects are a convenient way to store titles for multiple jobs. For example, an event videographer shoots two weddings and a party and is editing all three in one week. Making each event into a separate project makes it easy to avoid editing the wrong titles (especially if some of the pages are similar).
- You can set up a project to store some standard text you expect to use often, such as an introduction page you use on all your productions.
- You can use projects to share the unit with other users by keeping each person's work in different projects. Example: A language lab has a TitleMaker 2000 and three teaching assistants use it to conduct language tests. Each assistant has one or more projects. There might be a project named "French 101," another named "German II," etc.
- You can create different, but related, presentations. Example: A sales manager is visiting three accounts on one trip. The manager wants to make the same presentation to each client but with different pages depending on the type of customer and their particular needs. To make this simple, the sales manager copies the material into three projects and modifies each project for a different customer. Each project is named after the intended account.
- *Hint: When you turn the unit on, project 1 is always displayed. Use project 1 for informational items such as messages between users.*

Viewing Projects

The Editing Screen shows one project at a time. The Page Index screen shows all pages and all projects in a list. In both cases, the page symbols always include a project symbol. The number after the project symbol indicates the number of the project that includes the page. For example, this page is part of project 3:



Creating a Project

Projects can only be created in the Page Index screen. Press PAGE INDEX. Position the cursor in any existing project and press COMMAND and NEW PAGE simultaneously. A new project will appear after the project that contained the cursor.

Once the new project has been created, press NEW LINE/OK to enter the Editing Screen and begin adding titles. If you don't add titles and/or name the project, it will be automatically deleted the next time you display the Page Index screen.

Naming a Project

Projects can be named. Names can act as a reminder of the purpose of a project. They are especially handy when you have many projects with similar contents.

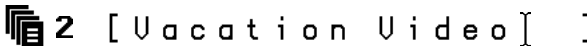

To add a name, position the cursor within the brackets that follow the project number in the first line of the project. Type the desired name. Names can be 20 characters long and can contain any characters. You can change a project name using the cursor and the normal editing functions.

Names appear only in the Page Index — only the project numbers are shown in the Editing Screen.

Removing a Project or Erasing its Contents



To delete a project, display the project using the Editing Screen. Press COMMAND + SHIFT + DELETE. A warning symbol appears to warn you the project is about to be discarded.

Press NEW LINE/OK to confirm this is what you want to do; press UNDO if you change your mind.

You can delete all the titles in a project without removing the project. Mark all text (press COMMAND + MARK START followed by COMMAND +

MARK END) and press DELETE. This leaves the project empty. If you have not named the now-empty project, it will be deleted the next time you leave the Page Index screen but if it has been named, it will be saved until you explicitly delete it or delete its name.

In summary, the rule is: Empty projects without names are automatically removed when you leave the Page Index unless the cursor is located in the empty project. Projects that contain titles or a name are never deleted automatically.

Moving Between Projects

Press COMMAND + SHIFT + UP or DOWN arrow to move between projects. This works whether the Page Index or the Editing Screen is displayed. When you are playing titles, you must switch to the Editing Screen or Page Index screen before you can switch projects.

Copying or Moving Text Between Projects

You can copy or move pages of text from one project to another. For instance, you might have a set of opening credits you use with all your productions permanently stored as project 1. Whenever you begin a new production, you create a new project and copy the standard credits from project 1 to the new project.

You can copy or move between projects using either the Page Index or Editing Screen. Page Index is convenient for transferring many pages at once since the pages are displayed in a more compact form, however it only allows you to move or copy entire pages. If you want to move parts of pages, use the Editing Screen (or use the Page Index to move the whole page first, then use the Editing Screen to delete the portion you don't want).

- Mark the pages you want, using MARK START and MARK END. (In Page Index, you can only mark whole pages.)
- Press COMMAND + SHIFT + UP or DOWN arrow to move the cursor to the desired project. Use the arrow keys to locate the desired location in the project.
- Press COPY or MOVE and the marked pages will move or be duplicated at the new location.

Chapter 9 • Changing Titles

You can easily make changes to the text on the screen. You can delete or insert new text, reposition it, and more. You can even copy or move a section of text without retyping.

Undo

UNDO



Suppose you delete text and then realize you prefer the way it was. The UNDO key lets you change your mind — it restores the deleted text. Note that UNDO only restores the last text you deleted. Any additional action, such as typing new text, makes the deletion permanent.

Simple Changes



The DELETE key removes the character before the cursor.

To make a simple change, use the arrow keys to position the cursor *after* the text you want to change and press DELETE. Each time you press the key, the letter before the cursor will be removed. Type some new letters and they will be added at the cursor location.

Marking Text for Major Changes

You can delete, copy, or move large blocks of text at once. To do this, you first *mark* the text you intend to change. Marked text is bracketed by special marking characters so you can see where it starts and ends. Any changes you make will affect all lines that contain the marked text.

To Mark Text:

- Position the cursor just *before the first letter* you plan to change. Press MARK START. Note the MARK START character (∂) which marks the start of the text.

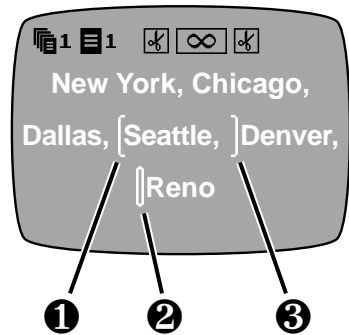

The word “Seattle” has been marked in this example.

- Position the cursor *after the last letter* you wish to change and press MARK END (⌘).

You can change the markings — simply move the cursor to a new place and press MARK START or MARK END again and the start or end point will move to the new location. The mark characters always show you what text is marked.

The cursor changes to a “fat cursor” (Σ) when text is marked. This is handy when marked text is out of view, to let you know that changes could affect off-screen text.

You can remove the marks completely by pressing UNDO.

Marking Whole Lines and Pages

If you want to copy, move, or otherwise change an entire line of text, place the MARK START character at the *end of the preceding line*, rather than placing at the start of the line you want. This way, the marked selection includes the invisible NEW LINE character that created the line. This character “contains” the characteristics of the line following it, so when the line is copied or moved, the characteristics will come along.

Hint: To mark all the text on a page, press SHIFT while you press MARK START followed by SHIFT + MARK END. To mark all text on all pages, press COMMAND as you press MARK START followed by COMMAND + MARK END.

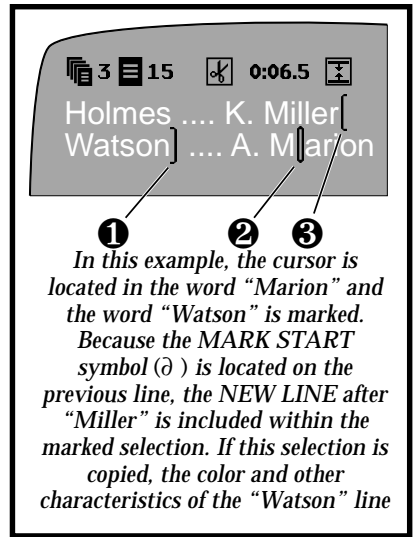

Deleting Marked Text

Press DELETE immediately after marking text and the marked text will disappear. To prevent accidental erasure, the cursor must be located just after one of the marks.

If you accidentally press DELETE, press UNDO immediately and the text will come back.

Replacing Marked Text

To replace a block of text with something new, mark the text and delete it as described above. The cursor will remain where the deleted text was so you can type something new to replace it.

Moving and Copying Text

Suppose you want to move some text elsewhere on the screen. Or you'd like to copy some text so it appears in two or more places. Or you'd like something to appear many times on a page. You could retype it — but fortunately, there's an easier way.

Mark the text, as described previously. Be sure both the start and end points are marked.

- Move the cursor to a new location and press MOVE. The marked text will disappear and reappear at the new spot. The text will still be marked so you can make more changes.
- Move the cursor to a new location and press COPY. The old text will stay where it was and a new copy of it will appear at the cursor's location. The new copy will be marked so you can COPY again to make more copies, or make other changes.

Example:

You are creating a business presentation with a list of cities that will be visited and decide to change the order of events to move the Paris and Venice visits after the London visit. To do this, you mark the lines that contain Paris and Venice. You position the cursor after London.

When you press MOVE, the marked text will move to the cursor location:

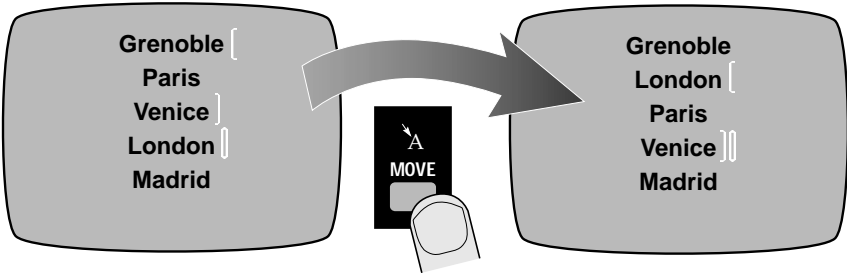

Pressing COPY instead would have duplicated the marked text at the cursor's location:

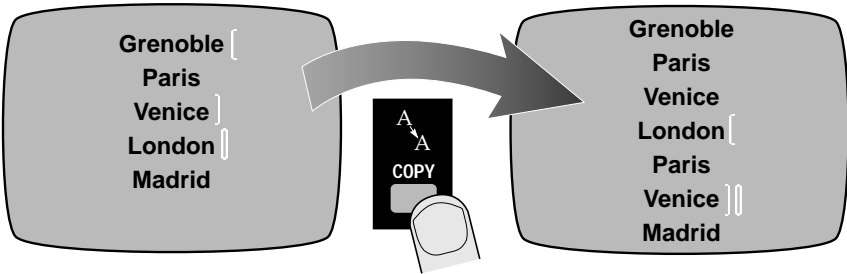

Oops?

Note that UNDO does not reverse a copy or move operation. However, you can undo the operation by immediately moving the cursor back to the original location and pressing MOVE.

Memory

If this appears when you copy text, it means the copy filled all of memory. You will need to remove some text before you can add more.

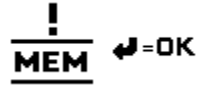

Multiple Copies

After you copy, the newly copied text is marked. This makes it easy to make many copies of the marked text. Simply press COPY as many times as you like. COPY is pressed twice in the following example:

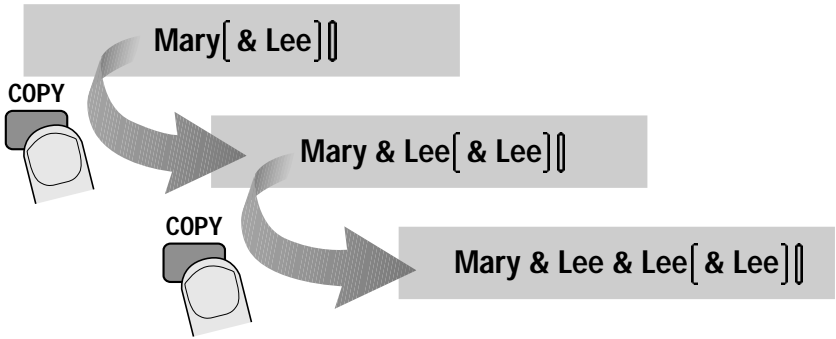

The Characteristics of Copied and Moved Text

Suppose you copy some red text to a new location, where the text is blue. Will the copied text be blue or red?

There is an invisible NEW LINE character associated with each line. It is located at the end of the previous line of text. If the NEW LINE character is included in the marked text, then the characteristics will move with the text.

- If you copy part of the line, but no NEW LINE characters, the letters will take the characteristics of their new home. In this case, the text would be blue.
- If you place the MARK START at the end of the *previous* line, then the NEW LINE character will be included and the characteristics of the line will be copied as well. In this case, the resulting text would be red.

All this applies to other characteristics as well — fonts, outlines, borders, etc.

Chapter 10 • Positioning Text

You can automatically center each line of text or you can position it against either the right or left edge of the screen. You can also adjust the vertical position of the text on each page, centering the text or positioning it at the top or bottom of the page.

POSITION



When you type text, it automatically appears at the center of the screen. As you type more, the whole block of text remains centered. You can change this using the four-arrow POSITION key.

Positioning Horizontally: Left, Right, Center

Position the cursor on a text line (or mark text in several lines, as described in “Marking Text for Major Changes,” in Chapter 9, “Changing Titles”). *Press and release* the POSITION key, then press the RIGHT or LEFT arrow on the arrow keypad. The selected lines will change position, between the left side of the screen, the center, and the right side.



You can position many lines at once by marking text. Any line that contains any marked text will change.

Positioning Vertically: Up, Down, Center

You can also automatically position the text vertically, making it appear at the top, middle, or bottom of a screen.

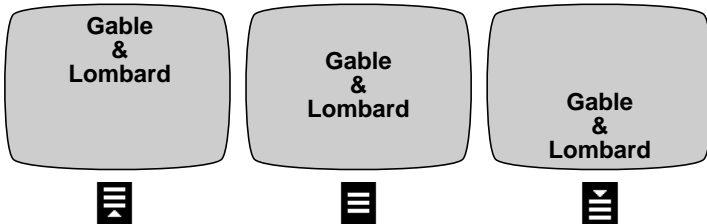

Position the cursor anywhere in the page you want to change. *Press and release* the POSITION key, then press the UP or DOWN arrow on the arrow keypad. The text on the Editing Screen will not change. Instead, the new page symbol will change to show you the new position. The text itself won’t show its new positioning until you press PLAY.

You can vertically position many pages at once by marking text, then adjusting the position. Any page that contains any marked text will be changed.

Additional Positioning Hints

You can fine-tune the horizontal positioning by adding spaces to the front of each line, or using tabs (see the section, "Tabs," in Chapter 6). You can fine-tune the vertical position on a page by adding blank lines to the page (press NEW LINE/OK a number of times). Since the height of a line is determined by font and size, you can further fine tune vertical positioning by changing the font and size of the blank lines.

Chapter 11 • How to Use Menus

Fonts, colors, and other characteristics are defined using menus, which show all the available choices.

Concept

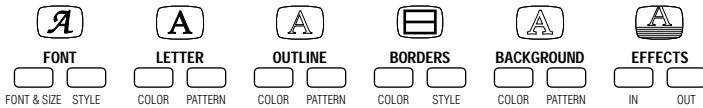

The keys in the top row are called *menu keys* because when you press one, you see a *menu* on the screen. Like the menu in a restaurant, TitleMaker 2000 menus are simply lists of what’s available.

In this menu, for example, you can choose the style of your titles — shadow, outline, bold, and letter spacing. Note that you choose from actual examples of the style, rather than abstract names.

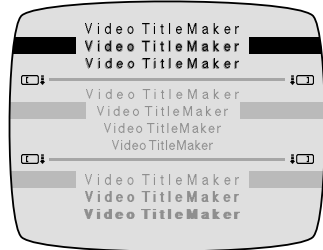

Sub-menus

Menus can contain “sub-menus” which show additional choices or alternate ways of making a choice. In the menu shown in the illustration, there are three sub-menus. The top sub-menu is used to add outlines or shadows to the titles. The middle sub-menu changes the spacing between letters. The bottom sub-menu is used to make the titles bold.

The MARK START key is used to determine which sub-menu is active. The TAB and MARK END keys can also be used. The inactive menus are dimmed (changed to a subdued gray) to show they’re not in use. In the example, the top sub-menu is active (the others are grayed).

The color menus are slightly different: the bottom sub-menu (which contains a palette of colors) is not grayed. Instead, the triangle-shaped highlight arrows tell you which sub-menu is active.

Highlights and Choices

One item in the active sub-menu is *highlighted* to show the current choice. The arrow keys are used to move the highlight to make a different choice.

Using the Menus

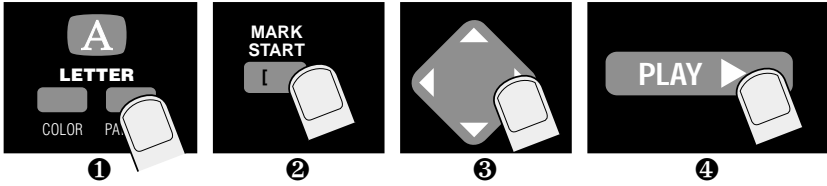

Using a menu is simple:

- Position the cursor in the line you want to change, or mark the text you want to change.
- ∂ Press the appropriate menu key.
- Σ If there are sub-menus containing additional choices, use MARK START to determine which sub-menu is active (see the previous section, “Sub-menus”).
- Π Use the arrow keys to highlight the desired choice.
- π When the correct choices are highlighted, press one of the following:
- NEW LINE/OK to make the choice and return to the editing screen.
 - PLAY to make the choice and play the page, as changed.
 - UNDO or DELETE to return to the editing screen without making any changes.
 - Another menu key to make the indicated changes and immediately move to another menu to make additional changes.

Chapter 12 • How Characteristics Affect Text

Some characteristics affect lines and others affect pages. This chapter describes what is affected and gives strategies for efficiently creating titles with the characteristics you desire.

Concept

The term *characteristics* refers to all the ways titles can be modified — font, colors, effects, scrolling, etc. Line and page position are defined using the POSITION key (Chapter 10). All other characteristics are defined using menus (Chapters 11-17).

How Characteristics Affect Lines and Pages

- Changes to Pattern, Background, and Effect menus always affect the *entire page*.
- Border and background color changes also affect the *entire page*.
- All other changes affect the *entire line*. You can't mix colors, styles, etc. on a line.
- If you have used the MARK keys to mark some text, changes to characteristics will affect all lines that contain *any* of the marked text.
- If no text has been marked, then changes affect just the line or page that contains the cursor.

Examples:

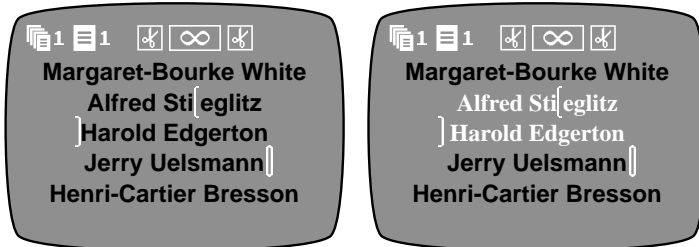

Text has been marked, so the font and color change is applied to all lines that contain marked text. The line that contains the cursor is unchanged since it contains no marked text.

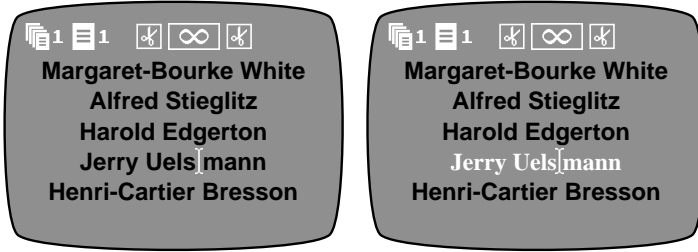

No text has been marked, so the font and color change is applied only to the line that contains the cursor.

Note: In the Editing Screen, several pages can appear on the screen at once. The background and borders of the entire screen will always be displayed using just one set of patterns and colors — the ones used by the page that contains the cursor — even if the other pages are defined using different patterns and colors. As you move the cursor to a different page, that page's patterns and colors will be used by the entire screen.

When PLAY is used to display the actual titles, each page will use its own patterns and colors.

Choosing Characteristics Before or After Typing the Text

There are two ways to create text with the characteristics you desire:

- You can choose the characteristics and then type new text. The characteristics are automatically applied as you type.
- You can type the text first and embellish it later.

New Lines and Pages Inherit Characteristics

When you create a new line, it has all the characteristics of the previous line — color, font, style, etc. Similarly, a new page has the characteristics of the previous page — effects, background pattern and color, etc.

In other words, all newly typed items inherit the characteristics of the character before the cursor.

Changes

It is not necessary to retype text to change characteristics. Simply mark the text and change it, as described in the following chapters.

Note that some changes, such as the use of a larger font or wider letter spacing, may push characters off the screen. Characters are never deleted when they are pushed out of view. To bring all the characters back on screen, you can choose narrower letter spacing, shorten the text, or break the line in two by positioning the cursor somewhere in the line and pressing the NEW LINE/OK key.

Copying Characteristics

You can copy characteristics, such as color, font, effects, etc. from one area of text to another. Mark the text you want to change. Move the cursor so it's immediately after a letter that has the desired characteristic. Press the appropriate menu key (LETTER COLOR, for instance). Press NEW LINE/OK and the marked text will be changed to match the character before the cursor. You can then use other menus to change other characteristics. To change all characteristics, simply press each menu key followed by NEW LINE/OK.

Chapter 13 • Fonts, Sizes, and Styles

TitleMaker 2000 offers a wide variety of ways to add flair to your titles. You can independently change font, size, and style, for hundreds of combinations.

Font and Size



FONT



FONT & SIZE STYLE

The first menu key brings up the FONT & SIZE menu. It is used to choose the *font* and *size* that will

be applied to each line of titles. (A “font” is the style, or shape, of the letters.)

Each font/size choice can be used as is or it can be doubled in size, horizontally, vertically, or both. The four symbols in the top sub-menu (∂) determine whether the size will be doubled. When you select any of the size-doubling options, the fonts at the bottom of the screen are displayed doubled, as they will appear on the screen.

The size-doubling options reduce the *resolution* of the letters, making them appear more jagged. For the smoothest letters, use fonts without size doubling. All the undoubled fonts provide maximum resolution.

The bottom portion of the menu (Σ) is used to choose the font. Use MARK START to make the bottom sub-menu active and use the arrow keys to

move the highlight bar (II) to the desired font.

For example, the screen shown here is composed of four lines. All share the same font but have different doubling options set using the top-menu. The top line is undoubled, the second line is doubled horizontally, the third

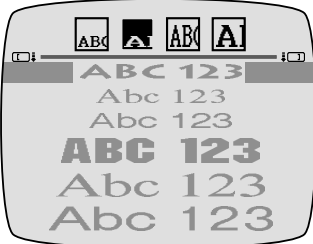
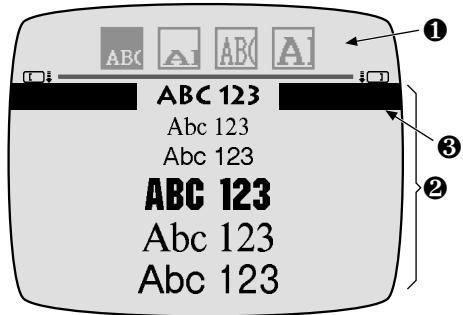

The fonts are displayed as they will appear. In this case, horizontal doubling is highlighted and the fonts are doubled horizontally.



line is doubled vertically, and the last line is doubled in both directions.

Upper-Case-Only Fonts, Mixed Fonts

Some of the fonts have only upper case letters. Whether you type upper or lower case letters, only upper case will be displayed on the screen. If you later change to a font that has upper and lower case, the letters will appear as you typed them.

One font (the cartoon-style font) contains two styles in one. Its upper case characters use a heavier style than its lighter weight letters:



Cartoon-style font typed as JULIUS CAESAR, as julius caesar, and as Julius Caesar

Hints on Using Fonts and Sizes

Here are a few tips from the pros.

- First, note that using too many fonts and sizes can create a loud, jumbled look. When you watch television, notice that professional productions seldom use more than a one or two styles at once.
- Combine fonts and sizes in a harmonious way, using two sizes of one font or using distinctive styles together. For example, when creating credits, put the character's name in one style and the actor's name in another.
- The smallest sizes should be reserved for minor information such as copyright notices. Note that they'll be somewhat harder to read after they have been recorded on videotape.
- The largest sizes are also special — save them for when you really want to grab the viewer's attention!
- Remember that the doubled size options create a more jagged appearance, so they should be reserved for when



FONT



FONT & SIZE STYLE

you need their larger sizes or the very tall or very wide effect.

Title Style

Use the Title Style menu to add shadows, outlines, bold, and other style modifications to a line of text.

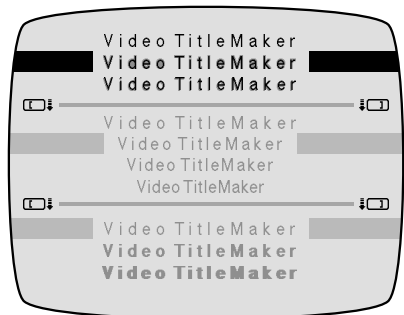

The menu is divided into three sub-menus. Use MARK START to activate the desired sub-menu and the arrow keys to highlight the desired choice.

Each line of titles you have typed can use a different style. You can choose any combination — shadow plus condensed type, outline plus bold, etc. In all, there are 36 combinations of styles. These styles are in addition to the colors, fonts, patterns, and other changes made by other menus.



Outlines and Shadows

The top section of the Title Style menu determines whether the titles are plain or have a shadow or outline.

An outline (J) is an edge that completely encloses the letter (π). A shadow (6) is similar to an outline except that it is slightly wider below and to the left of the letter, giving the letter a raised look. The shadow is a subtle effect, providing a slight separation between the letters and the background. All shadowed letters also have an outline — that is, a thin outline surrounds the letter and a slightly broader shadow appears to the left and below.

Special note: One font treats outline and shadow differently. (In the font list, it's the small font listed immediately after the handwriting fonts.) When outline is selected, a block effect is produced in which each letter is surrounded by box. You can use the Outline Color menu to change the color of the boxes. The block effect is only available with this font and the font does not have the capability of producing ordinary outlines. This font and this effect work particularly well in doubled sizes.

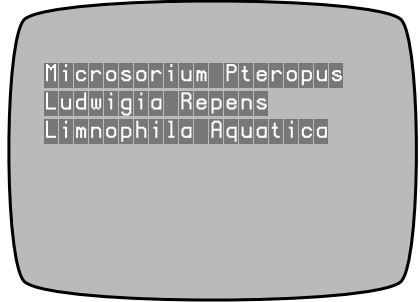

Spacing

The middle section of the Title Style menu lets you adjust the spacing between the letters.

Bold

The bottom sub-menu provides bold characters, to provide extra emphasis. (You can also create an extra-bold effect using the outline styles, as described in the hints, below).

Hints on Using Styles

- Use mixed styles with some caution. As with fonts and sizes, mixing too many styles creates a haphazard, overly complex look.

- Some combinations will make the text harder to read or less attractive. For instance, if you use the spacing option to place letters closer together, the edges of shadows, outlines, or bold letters may be clipped.



If letter spacing is set too tight, letters will be clipped, as in the bottom sample.

- **Bold letters** can make a bold statement. They can also improve readability when small titles are placed over a video background.

Hint: For extra bold letters, combine a bold setting with an outline in the same color as the letter. Note that very bold letters can cause the openings in letters such as “o” and “e” to close, making the results hard to read.

- Outlines and shadows are particularly useful for making titles stand out when the letters and backgrounds are similar in color. They also work well when titles are placed against a busy video background.
- The color and pattern of the outline or shadow can be set independently of the letter color — you can have blue letters with a rainbow patterned outline, for instance. By making the letter and background the same color, you can make outlined letters that look hollow. By making the outline and letter the same color, you can make the letters look fatter than usual, in a way that is different from the effect of bold letters. Other effects are possible — experiment!
- Choose narrow spacing to squeeze more letters on a line or give a busy, high-tension look. Use wider spacing to convey a more relaxed tone and make the titles easier to read. You can widen the spacing even more by typing one or more spaces between each letter.

VIDEONICS
VIDEONICS
VIDEONICS
V I D E O N I C S

Chapter 14 • Colors

The Video TitleMaker provides over a million colors! In a gaudy mood? You can use rainbow letters with blue outlines on a red tinted video background with green and white patterned borders!

Letters, backgrounds, outlines, and borders can be independently colored. The colors can be combined with patterns, including your moving video. Each line of text can use different colors and each page can use different background and border colors.

Color Menus

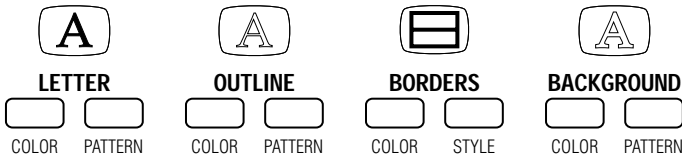

There are four Color menus; one each for backgrounds, letters, outlines, and borders. All work the same way.

About the Color Palette

The simplest way to choose a color is to use the palette of sample colors (∂) at the bottom of the Color menu.

Each Color menu shows the same colors. The palette list repeats — after the last color, the top of the list reappears. You can reach any color by moving up or down. Triangular pointers highlight the current choice and it is also shown in the sample patch (∏) in the middle of the screen.

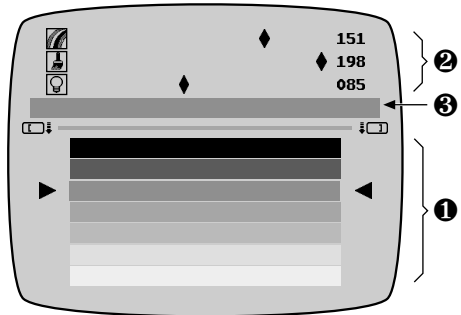

The swatches in the palette change as you use the TitleMaker 2000. When you first use the unit, the palette contains a set of pre-defined colors. As you create new colors, the new *user colors* are added to the palette, as described in the section, "User Colors," below.

Choosing a Color

Use MARK START, if necessary, to make the bottom sub-menu active. Then simply use the arrow keys to choose the desired color swatch. Press SHIFT while you press the UP or DOWN arrow key to scroll through the

colors a screenful at a time. Press COMMAND + UP jumps to the first of the pre-defined colors; COMMAND + DOWN jumps to the first user-defined color.

Press NEW LINE/OK or PLAY and the line or page you had selected uses the color you highlighted.

Creating a New Color

You can create your own custom color. Start by selecting a color from the palette (∂) at the bottom of the menu. Then modify the color using the color control bars (Σ) at the top of the menu.



Use MARK START to activate the control bars. Use the arrow keys to adjust the pointers on the control bars. The UP and DOWN arrows choose which of the three bars is active; the RIGHT and LEFT arrows adjust the sliding control of the active bar. Use SHIFT with the arrows to move the slider faster, use COMMAND to move the pointer all the way to the end of the bar. The number to the right of each bar shows its value, to make it easy to recreate a color later.

- The top bar adjusts the *hue* of the color — whether it’s red, yellow, blue, etc.
- The middle bar adjusts the *saturation* — the strength of the color.
- The bottom bar adjusts the *lightness* of the color between black on one end and white on the other.

These three adjustments are known as the HLS color model. It’s a bit like mixing paints. The hue control determines what color paint you are using. The saturation control shows how much of that color is in the mix. And the lightness control is something like mixing in more or less white or black paint.

The sample color swatch (II) in the middle region of the screen shows the resulting color. When the color is correct, press NEW LINE/OK and the color will be added to the user colors.

Using the User Colors

Whenever you create a new color, it is placed in the color palette. User colors are displayed with a shortened bar. They are sorted by color, not by the order they were created.

Hint: To quickly locate the user colors, press COMMAND + DOWN arrow and the first (top-most) user color in the list is highlighted. Press COMMAND + UP ar-

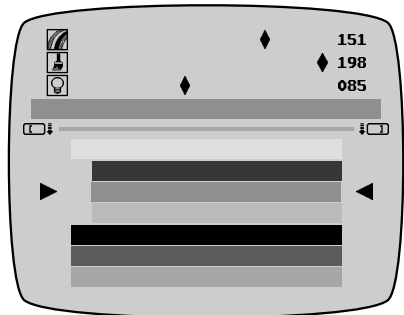

The user colors are indicated by a shortened color swatch.

row to highlight the first pre-defined color (which is just below the last user color).

The palette will hold up to 64 user colors. When there are 64 and you add another, the color closest to the newly created one will be removed. When a user color is removed from the palette, there is no effect on titles that use the color. The titles continue to use the color; it is simply not displayed in the palette.

There is no way to manually remove a color other than completely resetting the unit. Colors are removed only after 64 user colors have been defined.

Hints on Using Colors

- As with title styles, it's a good idea to exercise some restraint. It's tempting to use lots of wild colors but unless your video production is as wild as the colors, they may detract from the result.
- Don't forget black, white, and gray. With the amount of color we see every day on television, black and white can be a refreshing change. In addition, black, white, and gray tend to look sharper, especially for small fonts.
- Some colors work better on television than others, especially when they're recorded with a VCR. For instance, blue on green doesn't work well; bright reds tend to smear; white, black, and gray work well with almost everything. Extremely bright colors may not look as sharp when they're recorded.

Some background colors are "noisy" (they give a speckled or snowy appearance) when they're recorded by most VCRs. Dark colors, especially dark blue, are likely to be noisy. Solid red also tends to be noisy. Extremely bright purples and oranges may also be a problem. Medium colors are usually fine. Light colors, such as sky blue, and black or gray backgrounds work particularly well.

- Black or white outlines or shadows are often a good idea: They separate the letters from the background, making them more legible. If you're using small letters, it's best to use black or white, whichever contrasts the most with the background.

Chapter 15 • Patterns

With the TitleMaker 2000, you're not limited to plain solid colors. A variety of patterns, including moving "animated" patterns can be used. They can be colored and changed, for thousands of interesting variations. Finally, you can mix video into the background pattern or color for a "transparent pattern" or "tinted video" effect.

You can apply patterns to your letters, backgrounds, outline/shadows, and borders. Each page can use a different type and color of pattern.

Pattern Menu

The top of each Pattern menu (∂) shows four basic pattern choices. Use MARK START to make the top sub-menu active and use the arrow keys to select one of the pattern types. The rest of the menu changes appearance somewhat, adding or removing appropriate sub-menus, depending on which pattern you've selected.

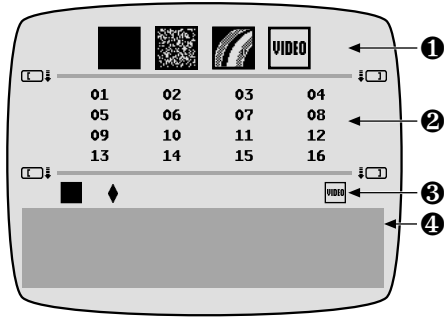

The *solid color pattern* displays a solid color, using whatever color you picked in the Color menu.



Pixel patterns are made up of dots and lines of various styles. The second sub-menu (Σ) chooses the style. The Color menu affects one of the colors used in the pattern; the other color is determined by the style you choose in the second sub-menu.



Rainbow patterns use brightly colored gradients. The second sub-menu (Σ) chooses from 16 styles of rainbow. The Color menu has no effect on the rainbow.



VIDEO uses your moving video material as the background.

A sample (π) at the bottom of the menu shows you what you've selected.

Selecting Different Rainbow and Pixel Patterns

If you selected a rainbow or pixel pattern using the top sub-menu, you can choose from a variety of styles. Use MARK START to make the second sub-menu active and use the arrow keys to highlight different pattern numbers. The patch at the bottom shows you the style you have highlighted. Note that some of the styles move. These are called animated patterns.

One Pattern per Page

Important note: All same-type patterns used on a page must be the same, whether used for background, letters, border, or outlines. For instance, if you use rainbow for outlines and borders, both will have the same color, style, etc. Likewise, all pixel patterns will match within a page. Each page can use a different color and style but within one page, you can use one rainbow and one pixel pattern.

Note also that in the Editing Screen, when two pages are on the screen at once, all patterns will match the patterns used on the page that holds the cursor. As you move the cursor between pages, all the patterns on the screen will change to match the ones used on the page that holds the cursor.

Mixing Video into a Background Pattern

You can mix video into a background pattern, blending both images on the screen. This creates a transparent effect as if the pattern were a see-through filter over your video. To do this, use the video mixing control in the Background Pattern menu. This control doesn't appear on other Pattern menus.

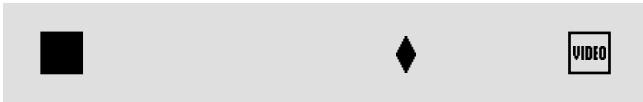

The position of the diamond-shaped marker determines how video and pattern are mixed in the background. When the marker is to the left, the pattern is opaque, with no video. As it moves to the right, more video is added and the pattern is gradually removed until, at the far right, the background is all video with no pattern.

Hints on Using Patterns

- **Important:** Rainbow patterns are very bright and should be used sparingly. Some video equipment may react to the brighter patterns. If you encounter undesired fringing or overly bright colors, try mixing the rainbow pattern with video (see "Mixing Video into a Background Pattern," above) or choose the more subdued patterns such as numbers 4, 5, and 11.

- When using complex patterns, pay special attention to the choice of title style and size, to avoid making the titles hard to read. Note that complex patterns may not be apparent when used as outlines or shadows.
- Try applying a rainbow pattern to the letters or their outlines. Because each letter covers only a portion of the rainbow pattern, it will look as if each letter is a different color.
- Add a rainbow pattern to a border and add a scroll effect (borders and scrolling are discussed in later chapters). The rainbow moves inside the border. A similar effect can be done with the pixel pattern.
- Try using video letters on a video background with a tint mixed into the background (use the video mixing control described in the last section to mix a solid color with the video background). Try this with and without outlines and shadows. The result is an interesting video-on-video effect.
- Mix a solid and transparent pattern. Use a the same pattern for the background and the letters. Then modify the background pattern using the VIDEO/PATTERN slider to make the background transparent. The result is patterned letters on a transparent patterned background.

Chapter 16 • Borders

Borders can be used to separate titles or to add an interesting graphic element. They can use any of the TitleMaker 2000's colors and patterns.



BORDERS



COLOR STYLE

You can place a horizontal border line above or below any line of text. You can create a box that surrounds a block of titles. Each page's borders can use a different color and pattern.

Border Style Menu

The top parts of the menu determine the border pattern. They work the same way as the other Pattern menus. Use MARK START to determine which sub-menu is active and the arrow keys to select the desired pattern and/or pattern style.

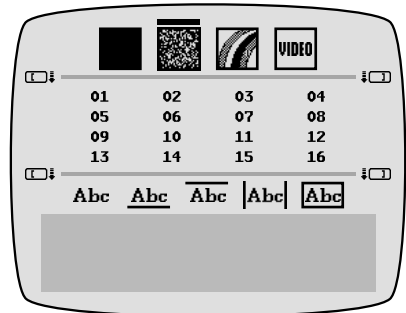

Note the "one pattern per page" rule, discussed in Chapter 15, "Patterns."

To create the border, use MARK START to make the last sub-menu active and use the arrow keys to choose the type of border you want:

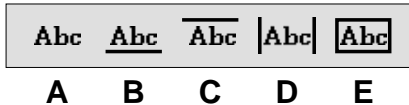

Using these choices, you can place a box around the text (E) or you can place a border line above (C), below (B), or along both sides (D). Borders are always applied to the entire line (that is, you can't border part of a line).

Placing a Box Around Text

To wrap a box around some lines of titles, mark the text as described in the section, "Marking Text for Major Changes" in Chapter 9. In the Border Style menu, choose the box symbol from the bottom sub-menu (E). The selected pattern will be wrapped all the way around the text lines that include the marked text. Note that if part of a line is marked, the entire line will be included.

You can box a single line without marking text: With no text marked, simply leave the cursor

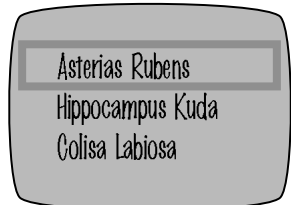
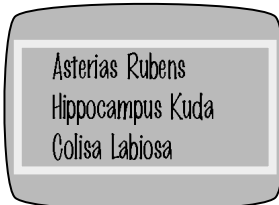

anywhere in the line and use the menu to select the box. A box will appear around that line.

Placing a Line Above, Below, or Between Text Lines

You can add a horizontal border line between any two lines of text. Place the cursor on one of the text lines and use the “line above” (C) or “line below” (B) symbol to place a border line either above or below the text. Adding a border line below one text line is the same as adding a border line above the following text line.

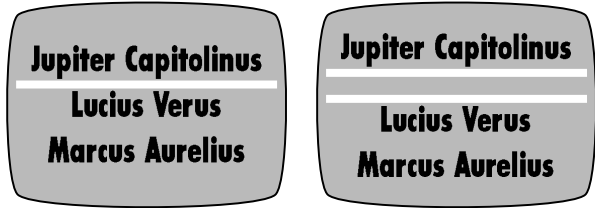

Hint: You can create a double border line. Create a blank line of titles. Add a border line below the new, empty line. Add a border line below the text line above it. This trick places a line above and below the blank line. You can change the distance between the two border lines by changing the font and size of the blank text line (which changes its height).

Side Bars

You can also place bars on the sides of text using the “side” symbol (D) .

Complex Borders

Whenever you change a border style, the new style replaces any borders already in place. You can create some interesting border patterns:



- ∂ Simple box. Mark text using MARK START and END and add the box border style. **1**
- Σ Box with lines inside. Create a box as in ∂ . Remove the marks by pressing UNDO and place the cursor on the second line, inside the box. Add the box border style. Repeat for each line in the box. **2**
- Π Box plus lines. Add a blank line above and below the box. Set the blank lines to the smallest Font & Size. Add a border line below the blank text line above the box. Add a border line above the one below the box. **3**
- π Lines. Mark text, including the line of text following the last line. Add a border line above. Each text line will have its own border line. **4**

Hint: Don't forget that characters can make excellent borders. Use a row of bullet and pictorial characters (such as ACCENT + J), dashes, the letter O, etc. Make them hollow by making them the same color as background and giving them a contrasting outline.

Removing borders

To remove borders, mark the text and choose the no-border symbol (A) in the BORDER menu.

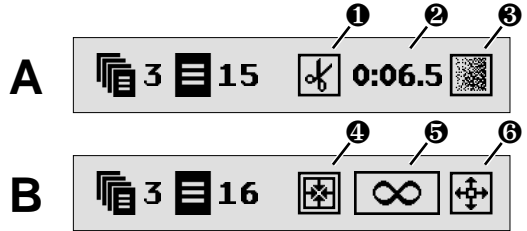

Chapter 17 • Effects, Scrolls, and Crawls

Effects provide interesting transitions between pages of titles. They include simple cuts, fades, wipes, slides, scroll, and crawl.

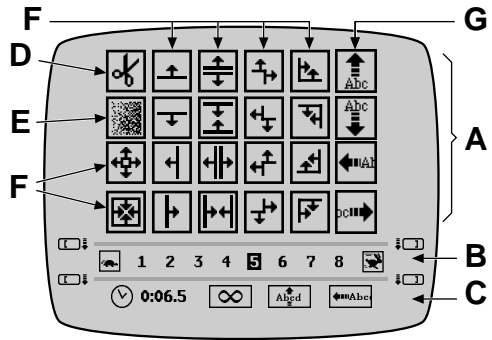

TitleMaker 2000 includes a variety of transition effects. You can use one effect to introduce a page of titles and a separate effect to end the page. Each can be set to any of eight speeds. You can set a duration for each page to determine how long it will be displayed before the out-effect removes it. You can set an infinite duration to display a page until you press PLAY again. You can also use scrolls and crawls, at any of eight speeds and in four directions, to make your titles march across the screen.

Page Symbols

The Editing Screen includes a set of *page symbols* at the start of each page. In addition to the project, page number, and vertical positioning of the text on the page, they tell you which effects have been set to start and end the page, whether the page will scroll or crawl, and how long the page will be displayed between transitions.

In the examples shown, page bar **A** shows a page that starts with a cut (∂), remain on the screen for 6.5 seconds (Σ), and ends with a fade (Π).

The next page (**B**) opens with an imploding wipe (π) (all four edges sweep in to the center), remains on the screen until PLAY is pressed (\downarrow), and ends with an exploding wipe (\odot) (the edges sweep from the center out to the edges).

Effects Menus

The Effects In menu contains three sub-menus. It is used to determine which effect will be used to start the page.

The Effects Out menu is used to choose the effect used to remove the page. It is identical (and works the same way) except that the bottom sub-menu is omitted.

Transition Effects: Cuts, Fades, Slides, and Wipes

- A *cut* (**D**) makes the page appear or disappear instantly, without any transition. The speed setting doesn't affect a cut.
- A *fade* (**E**) causes one page to fade away, then makes the next one fade in.
- In a *wipe* (**F**), a line or corner sweeps across the screen. If the wipe is an Effect In, the moving boundary reveals the new page of titles in its wake. If it's an Effect Out, the wipe removes the titles. The TitleMaker 2000 includes 18 wipes. Any of them can be used as an Effect In or an Effect Out.
- A *slide* or *half-scroll* (**G**) causes the entire page of titles to slide on or off the page.
- The in- and out- transition effects can be different. For instance, you could have titles fade in, then wipe away. You could have them slide in from the right, hold for a few seconds, then slide out the bottom.

Slide Notes

- Horizontal slides become jittery (vibrate) when the page contains too much text or the slide is too fast. To remedy this, reduce the amount of text on the page, split the text into several sequential pages, slow down the slide, or use a vertical slide.

Vertical slides (up or down), scrolls, and crawls are smooth at all speeds.

- If the text does not all fit on the page, text may be cut off, depending on slide direction and position of the text on the page. For instance, if a line that is wider than the screen, a horizontal slide stops when the text reaches the edge. Characters that are past the training edge are not displayed. You can display the missing characters by editing the page so all characters fit — break the line into two or use a smaller font, size, or style.

Choosing a Transition Effect

Start with the normal Editing Screen and place the cursor on the page you want to assign effects. Press EFFECTS-IN or EFFECTS-OUT.

Use MARK START to highlight the top sub-menu and use the arrow keys to highlight the desired effect. In the Effects In menu, the selected effect will be used to introduce the titles; in the Effects Out menu, it will be used when the page is removed from the screen.

Setting the Transition Speed

The second sub-menu (**A**) determines how quickly the effect will occur. "1" is the slowest speed, "8" is the fastest.

Displaying the Page

The third sub-menu (**C**, previous page), which appears only in the Effects In menu, determines how the title is displayed after the In-Effect is performed. You can display the page for a fixed amount of time, cause it to remain until it is manually continued, or use a scroll or crawl.

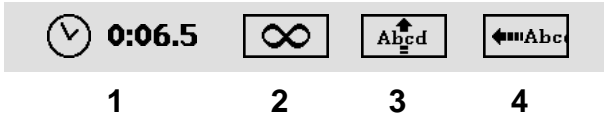

To use this sub-menu, highlight it using MARK START, as usual. Use the RIGHT and LEFT arrows to highlight the appropriate symbols and change their settings, as described in the following sections.

Setting Duration

To set a fixed duration, highlight the numbers next to the clock symbol (1). The numbers show the duration of the page — how long it will be displayed — in minutes, seconds, and tenths of seconds. They can be set from 0:00.0, which will display it just for an instant, to just under ten minutes.

Highlight the clock symbol and its numbers and type a value, using the number keys. To set a duration to 10.5 seconds, for instance, you would type 1, then 0, then 5. If you enter 60 or more as the number of seconds, the TitleMaker will convert it to minutes — 72 seconds would be changed to 1:12.0, for example.

The numbers scroll in from the right. If you make a mistake and want to re-enter the number, press 0 several times first, to clear the number.

Hint: To display a page longer than 9:59.9, duplicate the page using COPY (“Moving and Copying Pages,” in Chapter 7). End the first page and start the second page with cuts. The cuts will be invisible, since both pages are identical, and the result will be that the two pages will appear as one. You can repeat this to display a page as long as you like.

Infinite Duration

You can set a page to “infinite” duration — when it’s played, the page will remain on the screen until the PLAY key is pressed again. To do this, highlight the infinity symbol (2).

Scroll and Crawl

The last two symbols in the bottom sub-menu indicate that the titles on the page should move across the screen in a *full-page scroll* (3) or a *crawl* (4).

- In a scroll, the page of titles will move up, starting at the bottom of the screen, and continue to scroll off the top, the way credits are generally

done at the end of a movie. The color, font, and other characteristics of each line will be preserved. Borders will scroll as well.

- In a crawl, the titles turn into a single line of text and move across the screen from right to left, until they disappear at the left edge of the screen, the way a news bulletin is displayed over a television show. A space is inserted between each pair of lines. If two lines have different characteristics, the first line will crawl off the screen before the second one begins its crawl.



You can make a crawl occur at the top, bottom, or middle of the page, depending on whether the page is set for top, middle, or bottom vertical positioning (as described in Chapter 10).

Scroll and Crawl Notes

- When you use scroll or crawl, the transition effects for that page are disabled. You can't combine fades, wipes, and slides with a scroll or crawl.
- Use the speed setting of the In Effect's menu to set the speed of the scroll or crawl.
- A scroll is similar to a slide-up except that it scrolls straight through, never stopping in the middle. In addition, a slide can be in any of four directions and it is possible to make a page slide in one direction and out another.
- If a page has more than 40-60 lines (depending on the amount of text in each line), it may be too long for a vertical scroll. If the memory warning symbol appears when you attempt to play the scrolled page, break it into two pages or remove some lines.

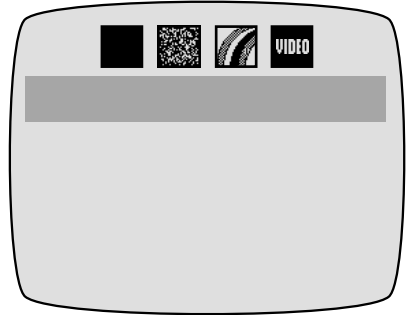

Hints on Using Effects

- Use simple effects most of the time, reserving fancy effects for when you want to attract attention, such as when using the TitleMaker 2000 to create video presentations.
- Use complementary effects for in and out. For example, try a wipe from the center for the in effect; then wipe back to the center for the out effect.
- Try a medium-speed slide to start a page and a high-speed slide at the end.



- When pages use different background or border colors and patterns, most effects will happen in two steps. For example, suppose you use fades to change from titles on a red background to titles on a green background. The titles on the first page will fade first, leaving the red background. Then the background will cut to green, and the in effect for the second page will occur. For the simplest effects, use the same background color and the same patterns on both pages.

Chapter 18 • Superimposing Titles

Titles can be superimposed over any video source.

Superimposed titles are often used in professional productions to identify people, places, times, settings — or the score of the game! They can also be used for subtitles or just as a way to play credits with an interesting background. TitleMaker 2000 allows you to superimpose. Effects, such as scrolling, can be used to bring titles in and out over the source video.

Superimposing Titles on Video

To superimpose titles on video, change the background pattern to VIDEO (rather than a solid color or pattern) as described in Chapter 15, “Patterns.”

- Position the cursor on the page that contains the titles you wish to superimpose.
- Press the BACKGROUND PATTERN menu button.
- Use MARK START to activate the top sub-menu. Use the RIGHT arrow key to highlight the VIDEO symbol. Press NEW LINE/OK.
- Confirm that your video source is running (start the VCR or camcorder) and press PLAY.

The OUTPUT monitor shows your page of titles superimposed over the source video.

Superimposing Titles on Video with a Transparent Pattern

You can mix a background color or pattern with the video, creating a see-through pattern effect:

- Use the top sub-menu in the BACKGROUND PATTERN menu to choose solid color or a pixel or rainbow pattern.
- Use MARK START to highlight the bottom sub-menu (the Video/Pattern slider). Use the RIGHT and LEFT arrow keys to select a mix between video and the pattern.

command ▼

PLAY ▶

- Press NEW LINE/OK.

Making Titles Come and Go

You can make superimposed titles appear for a while, then disappear. You can make them appear using an effect, such as a fade or slide, then cause them to disappear using another effect.

To do this, place blank pages with video backgrounds between pages of titles.

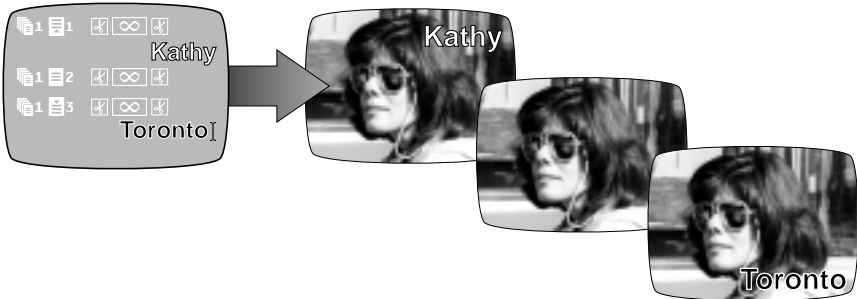

- Create a page of superimposed titles.
- At the end of the page, press NEW PAGE but don't type anything on this page. Set its background to VIDEO.
- Press NEW PAGE again and type the next titles.

When you play these pages, the first titles appear, then transition to the blank page. Since this page is empty and the background is plain video, the result is that the titles simply go away. The next page can then introduce more titles.

You can change the duration of each page to control when it appears and disappears or you can play the pages manually (Chapter 19) to introduce them on cue.

Add effects to these pages (fades, wipes, scrolls, and slides) to add interest to the titles as they come and go.

Chapter 19 • Playing Titles

You can play titles many ways. Like a VCR, TitleMaker 2000 allows you to play titles in forward or reverse, at various speeds.

After you have created and edited your titles using the Editing Screen, you are ready to *play* them. Playing titles displays the titles you have typed on the screen with the backgrounds, effects, positioning, and other details you have selected. The resulting titles can be recorded or displayed.

TitleMaker 2000 provides many ways to play titles. You can play automatically or manually, in forward or reverse. You can play some pages or all of them. You can even play a series of pages repeatedly, to create an eye-catching "video billboard." This chapter describes the different methods. They are summarized in the list at the end of the chapter.

Projects

Titles are always played from the current project. To play titles from a different project, you must switch projects by pressing COMMAND + SHIFT + UP or COMMAND + SHIFT + DOWN until you see the project you want to play.

Important Concepts

- *If any pages are marked*, the PLAY key plays those pages over and over again.
If no pages are marked, play starts with the page that contains the cursor and continues until the last page in the project is played.
- Pages are played using the durations, effects, and other choices you set up when you created the titles. Each page will appear for the amount of time you specified using the duration option in the Effects In menu (Chapter 17). The effects you specified will be used to transition between pages.
If you chose infinite duration for a page, display stops with that page until PLAY is pressed again.
- PLAY works the same way whether you start from the Editing Screen or from the Page Index screen.

Playing All Pages

The easiest way to play all pages in a project is to press COMMAND and PLAY at the same time. COMMAND + PLAY ignores marks and the cursor location. It plays all pages, starting with page one, using the effects and durations you have defined.

Playing Some Pages

To start playing from any page, be sure no text is marked (press UNDO if there are marks). Position the cursor on the desired page (using either the Editing Screen or the Page Index) and press PLAY. Play will begin at the cursor location.

To play a range of pages, mark text that spans those pages. Position the cursor anywhere in the first page you want to display and press MARK START. Position the cursor in the last page and press MARK END. Press PLAY and the marked pages are displayed in a “loop” — after the last marked page plays, the first marked page plays and the sequence begins again.

Playing Backwards

Press SHIFT while you press PLAY to play the pages in reverse order. You can also reverse the direction while pages are playing by pressing just the SHIFT key. Press PLAY again to continue playing in the forward direction. (You can also play backwards, a page at a time, using the LEFT arrow key, as described in a later section).

Pause

You can pause display at any time by pressing the SPACE bar (either half of the bar will work). The currently displayed page remains on the screen, even after its duration time has finished. Press SPACE again (or PLAY) to resume automatic play.

Hint: This is analogous to the pause or still function on a VCR.

Search (Cue and Review)

When you are playing titles, you can force the immediate display of the next page, even if the current page's duration has not finished. To do this, press PLAY. The next page is displayed immediately and automatic play continues from that page on.

You can back up a page by holding SHIFT and pressing PLAY. The current page ends, the previous page is displayed, and play continues in the reverse direction.

Hint: Pressing PLAY or SHIFT + PLAY is a handy way to zip through the pages without ending automatic play. It is analogous to the search (cue and review) features of a VCR.

Manual Play (Slide Projector Mode)

You can make the TitleMaker 2000 act as a slide projector, playing a new page with each button press. For example, if you are using titles to make a

live presentation, you would probably want each page to remain on the screen as you discuss it, moving on to the next page when you are ready.

You can define a project so that it *always* plays manually; or you can temporarily make a project play manually.

Making a Project Always Play Manually

To make a project always play manually, set all pages to infinite duration using the Effects In menu (Chapter 17).

You can do this as you create the titles — make the first page infinite and future pages will also be infinite, since new pages inherit the characteristics of the previous page.

Or you can change all the pages in an existing project to infinite duration by marking all pages and changing their duration. To do this, use COMMAND + MARK START followed by COMMAND + MARK END to mark all pages, then change the duration to infinity, using the Effects In menu.

Hint: You can mix manual and automatic play. For example, suppose you have a presentation and at one point, you want a series of titles to play automatically. Set the whole project to infinite duration but set timed durations for the pages you want to play automatically.

Notes:

- When you change the duration of all the pages, note that you cannot change it back by using UNDO.
- Don't press POSITION or enter any menus while all pages are marked. If you make any changes, all marked pages will be changed!

Playing Any Project Manually

You can make a project play manually even if it has durations set by using the arrow keys during PLAY.

Play the project normally using PLAY or COMMAND + PLAY. At any time, press the RIGHT arrow key to flip forward to the next page. Automatic play pauses — the page remains on the screen until you are ready to move on. Any durations that have been set are ignored. Continue to use RIGHT arrow to play forward manually, a page at a time. Use the LEFT arrow key to flip back to the previous page.

To resume automatic play, press PLAY twice.

Note the difference between using PLAY or SHIFT + PLAY to skip pages as compared to using the arrow keys: PLAY and SHIFT + PLAY flip to the next page and continue automatic play; the arrow keys flip to the next page and stay there, paused. Arrow keys also skip the out-effect.

The arrow keys are a very convenient way to rapidly flip through the pages to find a particular page.

Hint: The DOWN arrow key does exactly the same thing as the RIGHT arrow key. The UP arrow key does the same thing as the LEFT arrow. If you think of forward and back as up and down, use the UP and DOWN keys. If you think of them as right and left, use those keys instead.

Continuous Play (Video Billboard)

You can play all the screens in sequence, again and again, like a slide projector with a circular tray and an automatic timer. This makes the TitleMaker 2000 into an automatic "video billboard," useful for point-of-purchase display, cable television stations, hotel lobbies, bars, or any other application that requires a running program of video titles.

To do this, use MARK START and MARK END to mark a selection of text. Then press PLAY. The marked pages will play over and over. Any page with infinite duration will cause display to stop at that page until PLAY is pressed.

Hint: To continuously play all the pages, hold COMMAND as you press MARK START followed by MARK END to mark all the pages. This marks all the pages in the project. Then press PLAY.

Warning: Don't press POSITION or enter any menus while pages are marked. If you make any changes, all marked pages will be changed!

Leaving Play to Edit Again

To stop playing pages, press NEW LINE/OK and the screen you were using when you pressed PLAY (the Editing Screen or the Page Index screen) reappears. The cursor is located on the page you were viewing.

You can also end play with the cursor located where it was before you pressed PLAY. To do this, press UNDO instead of NEW LINE/OK.

Chapter 20 • Editing, Presentations, and Other Applications

Video titles are useful for more than just video editing. The high-quality titles, versatile play modes, projects and 8000-character capacity make the TitleMaker 2000 perfect for a wide variety of applications.

Applications

Here are some of the applications for the TitleMaker 2000:

- Video editing
- Business presentations
- Live displays (Video billboard)
- Nightclubs
- Retail point-of-sale display
- Hotel and business lobbies
- Public information displays (at an airport, for instance)
- Cable television information channels
- Broadcast slate generators
- Classroom presentations
- Self-paced demos

This chapter discusses three specifically: Video editing, presentations, and live video display (video billboard).

Video Editing

About Video Editing

Video editing translates raw camcorder footage into polished, professional productions you'll be proud to show. It usually involves two aspects: Removing unwanted footage and adding elements, such as titles and effects.

While film is edited by cutting and splicing lengths of film, videotape cannot be practically spliced. So video editing is done by selective copying. The raw footage is played by one machine and a separate VCR records the results on a new tape. The two machines are controlled, either by hand or automatically, to make sure the final tape contains just the scenes you want. An editing system such as Videonics Thumbs Up is often used to control the tape machines, making sure the correct scenes end up in the correct place. Whether you edit manually or automatically, the techniques for adding titles are similar.

Titles and Video Editing

Titles greatly enhance an edited video. For instance, they can be used to help tell the story, to introduce changes of time or place, to identify people or settings, and to add credits. The TitleMaker 2000 is the ideal companion for editing equipment of all kinds. You can add top-quality titles as you copy or edit your original videotapes.

How Titles are Added to a Production

Titles are never added to a tape that has already been recorded. Instead they are added as the original tape is being copied to a new tape. The original tape remains as it was and the titles (as well as special effects and other modifications) are placed on the new tape along with the original footage. This means you can use the same original tape for many different productions, with different titles added to each production.

Titles can be combined with the video or created as separate, standalone titles.

- The most common example of titles combined with video is when they are superimposed over video, as with subtitles or when video used as a pattern choice. Another example is where a screen of titles fades or wipes to the running video — video and titles are combined during the fade or wipe.

Be sure to read Chapter 18. It tells how to superimpose titles and explains how to make superimposed titles come and go.

- Standalone titles are independent of any video footage. They appear over the TitleMaker 2000's own colored or patterned backgrounds and no video footage is involved.

Connections

To use the TitleMaker in an editing setup, simply connect it between the VCR or camcorder that will be playing your original tapes, and the recorder, as described in Chapters 3 and 4.

Concept

You can create a page of titles and record it immediately, then create the next page and record that. But generally, it is more efficient to create a sequence of pages ahead of time. As the production is recorded, you trigger each page at the appropriate moment, displaying the page designed for that point in the production. Blank pages are added to the sequence anywhere the production calls for untitled video to be displayed.

If you are using an automated edit controller with a "GPI trigger" output (such as Videonics Thumbs Up), the controller can automatically trigger each page of titles at the right moments (as explained later).

Here are the steps for defining and using a sequence:

- View your original tape and visualize where titles will go. A “storyboard” (diagrams on paper that show how scenes, titles, and effects unfold) is a helpful aid.
- Design the titles and create the pages you will need, in the order they will have in the final production.
- Where scenes will play without titles, add a blank page with a plain VIDEO background. To do this, position the cursor at the end of a page and press NEW PAGE to create a new, blank page. Press BACKGROUND PATTERN and use the top sub-menu to choose VIDEO.

If you know exactly when each page of titles will be needed in the production, you can set the duration of each page and simply press PLAY and let the titles run. Alternatively, you can set the duration of all pages to be infinite and as the production is recorded, trigger each new page as required.

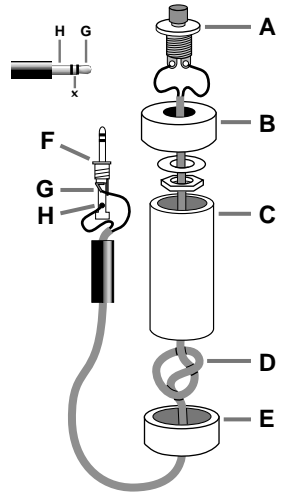

Projects

The project capability is a convenient way to hold many titling jobs at once. You can keep standard titles (such as your introductory titles, credits, and copyright information) in project 1 and copy then to each new production.

Triggering the Titles Manually

If your edit controller does not have a GPI output (described below), you trigger titles manually by watching the controller and using the PLAY key to trigger each page at the correct moment.

It is sometimes convenient to set the edit controller to pause on scenes that require titles, or to make a scene at a time, to make it easier to be there when a title needs to be triggered.

GPI Trigger

If your edit controller is automatic and has GPI (“General Purpose Interface”) trigger, the entire process can be automated, with each page of titles automatically triggered by the controller. A special cable is needed to connect the GPI jacks on the two devices. Chapter 3 describes how to buy or make one.

Here’s how to automatically trigger titles using Videonics Thumbs Up.

- First, you will need to connect the GPI jacks together using the appropriate cable (Chapter 3).

Warning: Always turn off power before plugging anything into GPI jack.

- As you mark scenes, press the “T” button where titles are to be triggered. You can trigger titles between scenes or anywhere in the middle of a scene.

- Set up your titles, page by page, remembering to insert a blank page with VIDEO background anywhere you want titles to disappear.
- When Thumbs Up creates the production, it sends a GPI trigger event to the TitleMaker at the moments you indicated. This triggers the next page of titles, exactly as if you pressed PLAY at that instant.
- The Thumbs Up manual provides more detail.

Presentations

Whether you are trying to demonstrate, teach, or persuade, video is a very effective medium. The built-in battery backup in TitleMaker 2000 means you can create a set of titles at home, then carry the unit anywhere you need to present. You can use projects to make multiple presentations on the same trip, or to share one unit with other users.

Hints:

- Copy the demo into the Editing Screen and use it as a starting point. Find interesting sequences and use the copy and move capabilities to move them where you need them.
- Use “builds” to tell your story. A build is a series of pages, each adding a point of information to the one before. There is an example in the demo. To create a build, first create the last page — the one with all the information. Set it to position the titles at the top of the page. Choose the cut effect as both the Effect In and Effect Out.

Duplicate the page as many times as you have points. Delete all but the first point from the first page. Delete all but the first two from the second page. Continue modifying all the pages until you reach the last page which will have all the points.

Advanced hint: Make the last point on each page (the one you will be discussing) a different color. As each new point appears, the previous points will be in the same color and only the newly appearing point will use the new color.

- When your titles are complete, videotape them for future use, after the titles have been removed from the unit. The tape is also a good safety net — although it is unlikely the TitleMaker 2000 will lose titles, it is wise to have a backup plan, just in case.
- When you turn off the unit, always wait until the power light is out before you unplug the unit. This minimizes the chance of accidental loss.
- Good presentation material techniques are especially important when using video. It is important to use large fonts. Keep the pages brief. Present details verbally. If you have a lot of information, break it into multiple pages.

- Include taped material where appropriate. For instance, after presenting the reasons your company has built a new facility, you can play a tape showing the facility. Add a blank page with plain video background at that point in the presentation so the video can be seen. You can add titles and effects designed to play over the video.
- Study the play modes carefully (Chapter 19) so you know how to play pages backwards and forwards, find a page using the Page Index, etc.
- You can use a remote pushbutton to trigger titles. This is useful when you are standing some distance from the titler. The following instructions describe how to make a remote trigger button.

INSTRUCTIONS FOR MAKING REMOTE TRIGGER

Tools required:

- A soldering iron and solder
- Wire cutters
- An electric drill.

Parts required:

- A 4-inch piece of 3/4-inch PVC pipe (C) and two end caps (B and E)
- 3-conductor, 22-24 gauge stranded wire cable (D)
- A "normally open momentary pushbutton switch" (A)
- A stereo 3.5-mm mini-pin plug (F)

Instructions:

Drill a 1/4-inch hole in the center of one PVC end cap (E) and a hole to match the pushbutton switch in the other end cap (B). Feed one end of the cable through the end cap with the 1/4-inch hole (E) and strip the ends of each wire. Tie a single knot (D) about 8 inches from the end of the wire. Slide the wire through the PVC pipe, the nut and washer, and the other end cap (B). Solder the two wires at the knotted end to the two poles on the switch (A). Slip the switch into the end cap and secure it using the nut and washer.

Solder the other ends of the cable to the plug (F). Connect to the tip (G) and the base (H) of the plug. Don't connect anything to the middle section of the plug (X). Push the end caps in place. After testing, you can glue the end caps using PVC cement, if you wish. Solder the wires at the other end of the cord to the poles from the tip and base of the stereo mini-pin plug. If you're unsure which poles are which, ask at the store when you make the purchase. Your new remote trigger plugs into the "GPI (CONTROL)" jack on the back of the TitleMaker 2000.

IMPORTANT! Any time you plug or unplug the GPI trigger, make sure the TitleMaker 2000 is turned OFF. Plugging or unplugging with the unit turned on can cause the loss of your work.

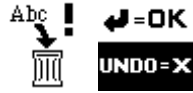

Live Titles

Many of the applications listed at the start of this chapter, such as video billboards, nightclub and restaurant uses, and in-store displays, have one thing in common: Titles play live, rather than being recorded.

- Live presentations often rely on automatic play in which each page is assigned a duration or uses scroll or crawl (Chapter 17).
- Continuous play (Chapter 19) makes it easy to have the program repeat over and over again.
- Projects make it possible to store multiple "programs." For instance, a restaurant might have one set of titles play during lunch and switch to a different project later in the day.
- Preview (Chapter 21) is designed for live use. Connect a small monitor to the preview jack and the Editing Screen and Page Index will only appear on that monitor. Anytime you edit titles, the regular output will carry whatever video is plugged into the IN jack (without titles). The audience will see the input video rather than watching you type! When you press PLAY, the titles again appear on both monitors.

Chapter 21 • Preview

An optional preview monitor is useful for live titling applications, allowing you to change titles without disrupting the live output.

About Preview

Imagine a restaurant with monitors that normally play sports videos. A TitleMaker 2000 is used to add phone messages, menu specials, and announcements to the screens, using superimposed scrolling and crawling titles. As dinner service begins, the manager wishes to change the specials. Without the Preview feature, the patrons would see the titles being changed. They would see the same thing the manager sees, including the Editing Screen, typing in progress, etc.

Instead, the manager uses a separate monitor, connected to the PREVIEW output. When the manager presses NEW LINE/OK, the Editing Screen appears only on the PREVIEW monitor. The normal output displays the sports video without titles and changes can be made privately.

Once the changes are complete, the manager presses PLAY and the titles play, as usual, on all monitors.

Using a PREVIEW Monitor

Preview is automatic. If a cable is plugged into the PREVIEW OUT jack, TitleMaker 2000 automatically uses it, displaying the Editing Screen only on the PREVIEW monitor. When you play titles, they are always displayed on both screens.

Forcing Preview Mode

You can also switch Preview on and off, regardless of whether the PREVIEW OUT jack is in use, by pressing COMMAND + P.

Appendix A • Advanced Techniques, Shortcuts, and Command Keys

Here are some hints and techniques that will become useful as you become experienced with the TitleMaker 2000. When “+” appears between the names of two buttons, press both keys at the same time.

Capacity

- The TitleMaker 2000 will hold over 8000 characters. You can check its remaining memory capacity by pressing COMMAND + M. A number will appear on the screen. It gives an idea of how much room you have left. The number gets smaller as you fill memory.
- Each line can hold up to 1000 characters. It's unlikely you would ever try to type that many but if you do, the memory-full symbol appears to remind you to start a new line.
- You can type as much as you like on a page. There is no fixed limit on the number of pages or on the number of characters that can be typed on a page. A page can contain more characters than will fit on the television screen, if you use scroll or crawl to march the titles on and off the screen.
- Scrolls can contain up 40-60 lines per page, depending on how many characters there are on each line. If a scroll is too long, the memory warning will appear when you attempt to play the page.
- Text that is typed past the edges of a page will not be displayed in the Editing Screen. The extra text is not erased. It will be displayed if you break the line into smaller pieces or use a smaller font, size, or style.
When you play the page using the full-page scroll effect, text that is beyond the top and bottom of the screen is displayed. When you play the page using a crawl, all the text on the page is displayed.
- When you fill a screen with small characters, the response of the unit will slow, taking as much as several seconds to enter a character. (The cursor will stop blinking when the response slows and start blinking again when the unit is ready for you to press another key.) To speed operation, break up the text lines to reduce the number of characters on the screen at once.
- Response may also slow as you fill memory.

Erasing Memory and Resetting Unit

- You can erase everything in a project by pressing COMMAND + SHIFT + DELETE. The trashcan symbol appears to warn you everything is about to be erased. Press NEW LINE/OK to confirm you really want to erase everything. Press UNDO immediately if you do not want to erase the project.
- To completely reset the unit, erasing everything and returning the unit to factory condition, remove the power cord and hold COMMAND + SHIFT while you plug the unit back in. Hold the keys until the power light goes out. **Warning: This will erase all projects, all colors, etc. You cannot undo this operation.**

Moving the Cursor

- In the Editing Screen, the COMMAND and SHIFT keys modify the arrow keys:

Modifier key	LEFT or RIGHT arrow	UP or DOWN arrow
SHIFT	Next start or end of line	Start or end of next page
COMMAND	Next start or end of line	Start or end of current project
COMMAND + SHIFT	Next start or end of line	Start of next project

- In the Page Index screen, SHIFT causes the arrow keys to move a screenful at a time. COMMAND causes the arrow keys to move a project at a time. COMMAND + SHIFT also moves a project at a time.
- SHIFT and COMMAND also modify the meanings of the MARK START and MARK END keys, in both the Editing Screen and the Page Index screens:
 - SHIFT + MARK START places a mark at the start of the current page and SHIFT + MARK END places a mark at the end of the page.
 - COMMAND + MARK START places a mark at the start of the current project and COMMAND + MARK END places a mark at the end of the project.

Projects

- Use COMMAND + SHIFT + UP/DOWN to move to the next or previous project.
- COMMAND + NEW PAGE, while the Page Index is on the screen, creates a new project.
- COMMAND + SHIFT + DELETE while in the Editing Screen erases the contents of a project.

Moving In the Color Menu

- In the bottom sub-menu (with the color palette), use SHIFT with the arrow keys to move the highlight a screenful of bars at a time.
- In the bottom menu, use + UP to first pre-Use COM-DOWN to first user-
- In the top use SHIFT RIGHT to pointer the color
- In the bottom menu, use + LEFT/ move the end of the

ABCDEFG abcdefg
 ABCDEFG abcdefg
 ABCDEFG abcdefg
ABCDEFG abcdefg
 ABCDEFG abcdefg
 ABCDEFG abcdefg
 ABCDEFG abcdefg
ABCDEFG abcdefg
 ABCDEFG abcdefg
ABCDEFG abcdefg
ABCDEFG
 ABCDEFG abcdefg
ABCDEFG
ABCDEFG abcdefg
 ABCDEFG abcdefg
ABCDEFG abcdefg
ABCDEFG abcdefg
ABCDEFG abcdefg
ABCDEFG abcdefg
 ABCDEFG abcdefg
 ABCDEFG abcdefg

tom sub-COMMAND move to the defined color. COMMAND + move to the defined color. sub-menu, + LEFT/ move the faster across setting bar. tom sub-COMMAND RIGHT to pointer to the bar.

Using Demo

- Press a demon-major fea-key will demo.
- Press DEMO to demo that the use of g u a g e demo is interna-Any key demo.
- Press + DEMO “locked” version of the English language demo. This demo will not stop until COMMAND + DEMO or COMMAND + SHIFT + DEMO is pressed.
- Press COMMAND + SHIFT + DEMO to see a “locked” version of the international demo. This demo will not stop until COMMAND + DEMO or COMMAND + SHIFT + DEMO is pressed.

the
 DEMO to see stration of the tures. Any stop the
 SHIFT + display a minimizes English lan-text. This designed for tional use. will stop the
 COMMAND to see a

- Press COMMAND + SHIFT + COPY to copy the English language demo into a new project.
- Press COMMAND + SHIFT + MOVE to copy the international demo into a new project.

Play Modes

- The current project is always the one played. To play another project, use COMMAND + SHIFT + UP/DOWN to switch projects.
- If text is marked, the PLAY key plays all the pages in the project that include marked text. The same pages are repeated over and over (looped play).
- If no text is marked, PLAY starts with the page that contains the cursor.
- COMMAND + PLAY: Starts playing from the first page in project, regardless of marks or cursor location.
- SHIFT + PLAY plays backwards. Pressing SHIFT during play switches direction of play.
- SPACE BAR pauses playing immediately.
- While pages are playing, the PLAY key goes to the next page immediately and resumes automatic play from that page.
- Arrow keys move forward and backwards, ceasing automatic play. One page is displayed with each arrow-key-press and out-effects are skipped.

Miscellaneous Hints

- You can adjust the TitleMaker 2000's video output to compensate for a television that is off-center. Press SHIFT + POSITION. A large rectangle is displayed. Use the arrow keys to adjust the rectangle until it is centered and press NEW LINE/OK.
- COMMAND + P turns Preview mode on and off.

Appendix B • Font Listing

TitleMaker 2000 includes 92 font/size combinations with a complete set of characters, including accented and pictorial characters.

Character Set

All fonts include the following characters except some fonts which include capital letters only.

A B C D E F G H I J K L M N O P Q R S T U V W X Y Z

a b c d e f g h i j k l m n o p q r s t u v w x y z

1 2 3 4 5 6 7 8 9 0

! @ # \$ % ^ & * () ° -

— = _ + “ ” ‘ ’

‘ ’

[] { } \ | ; : , . < > /

? ¢ £ ¥ ® ™ © •

← ↓ ↑ → ● ♥ ✓ ★ ◆ □

ç Ç æ Æ œ Œ ð Ó å Å ß « » ; ï

’

á é í ó ú Á É Í Ó Ú

、

à è ì ò ù À È Ì Ò Ù

..

ä ë ï ö ü Ä Æ Ì Ö Ù

~ ã õ ñ ã Õ Ñ

^

â ê î ô û Â Ê Î Ô Û

" " " " " "

Font Sample

TitleMaker 2000 includes 23 fonts in four sizes (plain, doubled vertically, doubled horizontally, doubled vertically and horizontally). Here is a sample of each font.

SPECIAL CHARACTERS

Refer to Chapter 6 for a complete listing, with explanations.

The following special characters are entered by pressing ACCENT and the indicated character at the same time. For instance, ACCENT + C indicates you press C and ACCENT together. “+” indicates that two keys are pressed together; you don’t push the “+” key. Capital letters are used for clarity; you don’t press SHIFT unless it is indicated.

* Note: TitleMaker 2000 offers “curly” quotes in addition to “straight” quotes. Curly quotes look like this: “ ” ’ ’ , as opposed to straight quotes which look like this: “ ” ’ ’ . It also has the “em-dash” (—), a dash that is longer than a hyphen (-). Note that the straight quotes in some fonts are actually slightly curled due to the style used by that font’s designers.

** For the degree symbol, type ACCENT + 7 followed by SPACE.

Ç	ACCENT + C
Ç	ACCENT + SHIFT + C
æ	ACCENT + A
Æ	ACCENT + SHIFT + A
œ	ACCENT + O
Œ	ACCENT + SHIFT + O
ø	ACCENT + 0
Ø	ACCENT + SHIFT + 0
ß	ACCENT + S
§	ACCENT + D
«	ACCENT + [
»	ACCENT +]
¡	ACCENT + 1
¿	ACCENT + /
¢	ACCENT + Q
£	ACCENT + W
¥	ACCENT + E
®	ACCENT + R
™	ACCENT + T
©	ACCENT + Y
°	ACCENT + 7; SPACE **
•	ACCENT + U
—	ACCENT + — *
‘	ACCENT + ; *
’	ACCENT + ; *
“	ACCENT + , *
”	ACCENT + , *

The following characters are not printed on the keypad.

←	ACCENT + arrow keys
↓	ACCENT + F
↑	ACCENT + G
→	ACCENT + H
✓	ACCENT + J
★	ACCENT + K
◆	ACCENT + L
■	ACCENT + L
□	ACCENT + L

ACCENTED CHARACTERS

The accents above the 2, 3, 4, 5, 6, and 7 keys are used *with other letters* to make accented letters. For instance, to type ü, you would use ACCENT + 4, followed by the letter U. The capitalized version (Û) would be displayed using ACCENT + 4, followed by SHIFT + U.

In this list, “letter” means the letter you want accented.

To Type:	Press:	Then press:
´	ACCENT + 2	SPACE
á, é, í, ó, ú	ACCENT + 2	letter
Á, É, Í, Ó, Ú	ACCENT + 2	SHIFT + letter
˘	ACCENT + 3	SPACE
à, è, ì, ò, ù	ACCENT + 3	letter
À, È, Ì, Ò, Ù	ACCENT + 3	SHIFT + letter
¨	ACCENT + 4	SPACE
ä, ë, ï, ö, ü	ACCENT + 4	letter
Ä, È, Ì, Ö, Ü	ACCENT + 4	SHIFT + letter
˜	ACCENT + 5	SPACE

Index

A

ACCENT 6
ACCENT key 27
accented characters
27, 82
adding a page 32
advanced techniques 76
antenna 12
appearing and
disappearing 65
applications 2, 70
arrow keys 7, 25, 43
audio 15

B

background color 52
backup 73
basic applications 2
basics 4
battery backup 73
block effect 50
BNC 12
bold 50
border box 58
border color 52
border line 58
Border Style menu 58
borders 58
removing 59
box 58
built-in demo 23
button, trigger 74

C

cable
GPI 22
cable TV 12
cables 12
cabling 11
capabilities 1
capacity 30
capacity, memory 76
capitals 26
CAPS LOCK 6
CAPS LOCK key 26
cartoon-style font 49
centering 17
CG
definition 1
chain 19
changing
characteristics 46
changing projects 36
changing titles 37
character generator
definition 1
character limit 30
character set 80
characteristics 7, 45

changing 46
choosing 46
concept 45
copied/moved text
40
copying 47
inheriting 46
characters
accented 82
special 82
choices 43
clearing all 77
color bars 53
color control bars 53
Color menus 52
color swatch 53
colors 52
hints 54
noisy 54
removing 54
columns 26
come and go titles 65
COMMAND 77
COMMAND + arrow keys
25, 26, 78
COMMAND + DEMO
23, 78
COMMAND + M 26, 76
COMMAND + MARK
END 77
COMMAND + MARK
START 77
COMMAND + NEW PAGE
77
COMMAND + P 75, 79
COMMAND + PLAY
9, 66, 78
COMMAND + SHIFT 77
COMMAND + SHIFT +
arrow keys
26, 77, 78
COMMAND + SHIFT +
COPY 78
COMMAND + SHIFT +
DELETE 35, 77
COMMAND + SHIFT +
DEMO 23, 78
COMMAND + SHIFT +
DOWN 36, 66
COMMAND + SHIFT +
MOVE 78
COMMAND + SHIFT +
UP 36, 66
command keys 76
complex borders 59
composite 12, 15
composite (RCA-style) 4
concept
characteristics 45
editing connections

19
menus 43
video editing 71
connecting
video source 17
Videonics
equipment 19
connecting monitors 15
connecting outputs 15
connection diagram 14
connections 4, 11
continuous play 69, 74
CONTROL (GPI)
16, 21, 72
control bars 53
copies
multiple 40
COPY 33, 39
copying
characteristics 47
copying between projects
36
copying demo 78
copying pages 33
copying text 39
crawl 9, 60, 62
crawl speed 61
creating colors 53
creating projects 35
curly quotes 28
cursor 5, 6, 25
moving 25
wide 38
custom colors 53
cuts 60

D

dash
long 28
defining colors 53
DELETE 35, 38
delete 7
DELETE key
7, 26, 32, 37
deleting 26
deleting a page 32
deleting marks 38
deleting memory 77
deleting projects 35
demo 5, 23
copying 78
copying into
memory 23
international 23, 78
locked 23, 78
using 78
DEMO key 23, 78
description 1
Digital Video Mixer 20

doubled fonts 48
doubled size options 49
doubling
horizontal 48
vertical 48
DOWN arrow 25
duration 62, 66
infinite 62
durations 9

E

edit controller 20
editing 19, 70
multiple source 21
single-source 20
Editing Screen
5, 25, 35
editing titles 37
effect speed 61
effects 19, 60
Effects In menu 60
Effects Out menu 60
em-dash 28
empty projects 35, 36
English language demo
23
enhancer 21
entering text 6
entering titles 25
equipment 3
erasing 26
erasing memory 77
erasing projects 35
extra bold 51

F

fade speed 61
fades 60
fat cursor 38
features 1
filter effect 56
FONT & SIZE menu 48
fonts 48
block effect 50
bold 50
cartoon-style 49
extra bold 51
listing 80
mixed 49
outlines 50
sample 81
shadows 50
spacing 50
upper-case 49
foreign characters 27
forward 66
full-page scroll 62

G

General Purpose Interface
16, 21, 72
GPI 16, 21
GPI trigger 72
guided tour 23

H

half-scroll 61
highlights 43, 52
hints
1, 11, 13, 18, 19,
34, 38, 42, 49, 50, 51,
53, 54, 56, 59, 62, 63,
67, 68, 69, 73, 76, 79
horizontal doubling 48
horizontal positioning 41
horizontal slides 61
hue 53

I

IN and OUT markings 13
infinite duration 62, 66
inheriting
characteristics 46
input 11
input connections 17
input selection switch 16
input selector switch
monitor 16
VCR 16
insert 7
inserting a page 32
international demo 78
introduction 1

J

jacks 12
jagged 48
jittery slides 61
jobs 34

L

language characters 27
learning from demo 23
LEFT arrow 25
letter color 52
letterspacing 50
lightness 53
limit
scroll 61
limits
character 30
line 30
line above 59
line below 59
LINE/TUNER switch 16
live titles 74
locked demo 23, 78
long dash 28
long pages 30
looped play 67, 69, 74
lower case 26

M

major changes 37
manual play 67
MARK END 38, 43
MARK START 37, 43
marking text 37
marks 37
removing 38
memory 40, 76
clearing 77
memory capacity 76
memory full 26, 76
memory-full symbol 26
menu 7
menu keys 7, 43
menus 43, 44
merging pages 32
mixed fonts 49
monitor 11
monitor input switch 15
MOVE 33, 39
moving between projects
36
moving cursor 25
moving pages 33
moving projects 36
moving text 39
moving the cursor 6
multiple
copies 40
multiple source editing
21

N

naming projects 35
navigating pages 31
NEW LINE/OK 6
NEW LINE/OK key 26
NEW PAGE 30
NEW PAGE key 6
newsletter 1
noisy colors 54

O

OUT jacks 15
outline color 52
outlines 50
output 11
OUTPUT monitor 12, 15
overscan 17

P

page
adding 32
copying 33
moving 33
Page Index 31
PAGE INDEX key 6, 31
Page Index screen 35
page number 31
page symbols
6, 25, 31, 60
pages 6, 30
rapid access 31

palette 52
pattern
see-through 64
transparent 64
Pattern menus 55
patterns 55
see-through 56
transparent 56
pause 67
picture centering 17
pixel patterns 55
PLAY 9
play 9, 66
PLAY key 5
PLAY Screen 66
Play Screen 5
playing all pages 66
playing backwards 67
playing continuously 69
playing in a loop 69
playing manually 67
playing quickly 67
playing some pages 67
point-of-sale display 70
POSITION key 9, 41
positioning text 9, 41
POWER 4, 15
power 5, 14
POWER button 14
power light 15
power supply 14, 15
presentations 70, 73
preview 74, 75
PREVIEW monitor
12, 75
PREVIEW OUT 4, 75
processor 21
project
deleting 35
erasing 35
names 35
project number 31
project symbol 35
projects 6, 34
copy 36
move 36

Q

QuickStart 4

R

rainbow patterns 55
rapid access
pages 31
RCA 4, 12, 15
record VCR 12
recorder 11
rectangle 17
registration card 1
remote trigger button 74
removing borders 59
removing colors 54
removing marks 38
removing projects 35

repeat play 69
replace 7
replacing text 38
resetting unit 77
resolution 48
response 76
reverse 66
revising titles 37
RF 12
RF (cable/antenna) jack
15
RF modulator 15
RIGHT arrow 25

S

S-video 4, 12, 15
sample colors 52
sample of fonts 81
saturation 53
SCART plugs 12
scroll 9, 60
scroll capacity 76
scroll length 76
scroll speed 61
see-through filter 56
see-through pattern 64
shadow color 52
shadows 50
sharing unit 34
SHIFT 6, 77
SHIFT + arrow keys
25, 26, 78
SHIFT + DEMO 78
SHIFT + MARK END 77
SHIFT + MARK START
77
SHIFT + PLAY 78
SHIFT + POSITION
17, 79
SHIFT key 26
shortcuts 76
side bars 59
single-source editing 20
sizes 48
skipping pages 67
slide 61
slide projector 67
slide speed 61
slides 60
slow response 76
smart tab 26
smoothness of letters 48
solid color pattern 55
spacing 50
special characters
27, 82
speed 61, 66, 76
straight quotes 28
sub-menus 7, 43
superimpose 64
superimposing 8
switch, trigger 74
switching projects 36

T

- TAB key 26
- television 15
- text
 - copying 39
 - editing 7
 - entering 6, 25
 - modifying 7
 - moving 39
 - revising 37
 - typing 25
- text color 52
- Thumbs Up 20, 22, 70
- title generator
 - definition 1
- Title Style menu 49
- titler
 - definition 1
- titles
 - entering 25
 - revising 37
 - typing 25
- transition effects 9, 60
- transition speed 61
- transitions 9
- transparent effect 56
- transparent pattern 64
- trigger 72
- trigger switch 74
- troubleshooting hints 18
- TUNER/LINE switch 16
- typing text 6
- typing titles 25

U

- UNDO 7, 38
- UNDO key 37
- UP arrow 25
- upper case 26
- upper-case-only fonts 49
- user colors 52, 53
- using demo 23
- using menus 43, 44

V

- VCR 11
- vertical doubling 48
- vertical interval time code 20
- vertical positioning 41
- vertical slides 61
- vibrating slides 61
- video billboard 69
- video editing 19, 70
- VIDEO OUT 17
- VIDEO patterns 55
- video processor 21
- video source 11
 - connecting 17
- videonics equipment
 - connections 19
- viewing pages 35
- viewing projects 35
- VITC 20

W

- warning
 - memory full 40
- wide cursor 38
- wipe 61
- wipes 60
- wiring 11

Y

- Y/C 4, 12, 15